

William B. Gould

RAYTHEON MFG CO
190 WILLOW ST
WALTHAM MASS
-21

electronics

radio, sound, communications and industrial applications
of electron tubes . . . design, engineering, manufacture

IRE Convention
papers report

+

Electronic
engine
indicators

+

Testing
electrolytic
condensers

+

Adjustment of
broadcast
Class-B amplifiers

+

Vacuum-tube
high resistance
ohmmeter

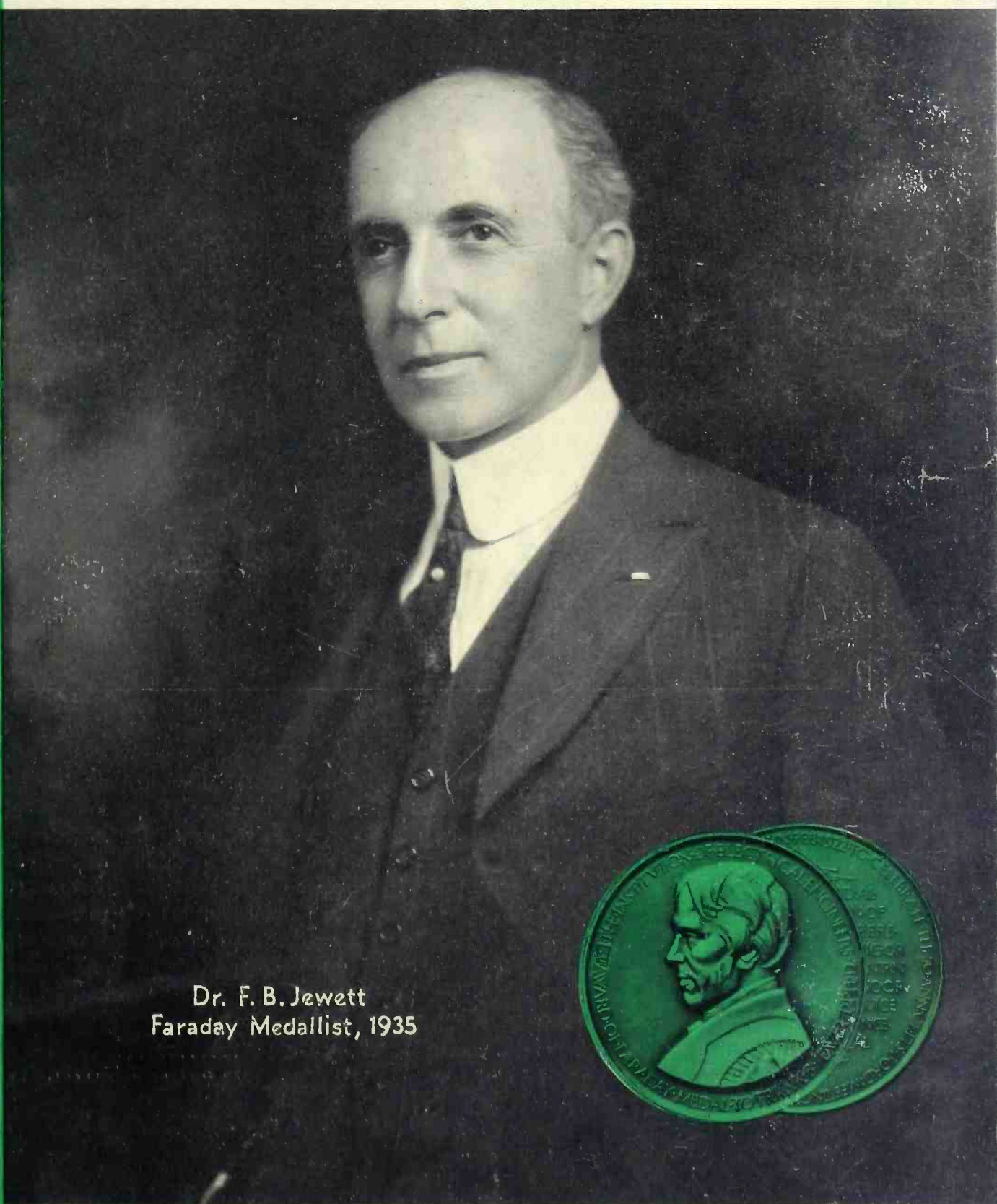

Dr. F. B. Jewett
Faraday Medallist, 1935



McGRAW-HILL PUBLISHING COMPANY, INC.

Price 35 Cents

JULY, 1935

In the interest of well designed radios we offer suggestion

No. 4 'CHIPPENDALE'

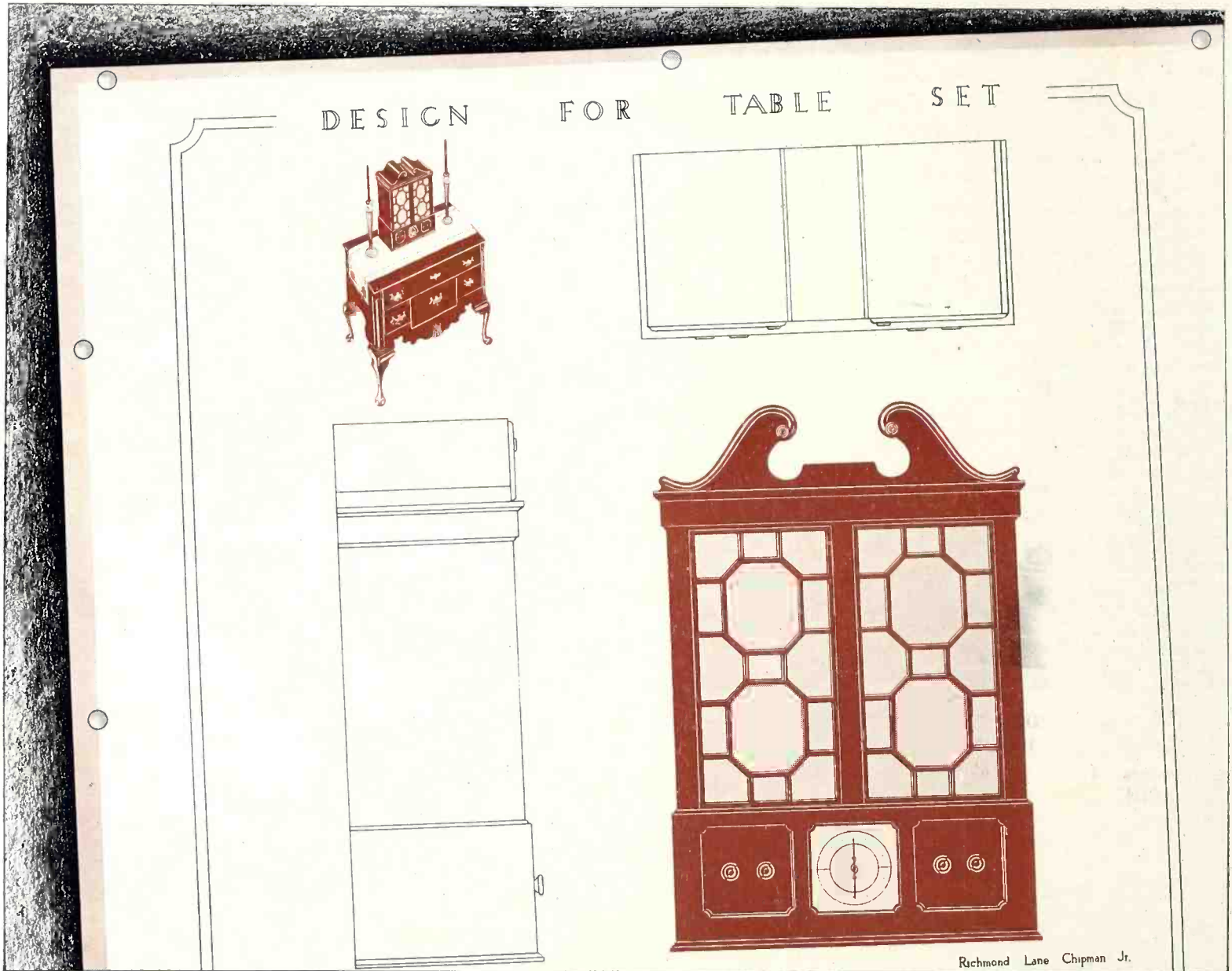

WE DERIVE the title for this design from the scroll motif of the pediment, a form much used by Chippendale in his designs for cabinets and clock cases. During the middle and late Georgian periods this scroll pediment motif was widely adopted by furniture designers and architects for the embellishment of doorways and over-mantles.

This "Chippendale" radio cabinet design is particularly well adapted

for accurate and economical reproduction in Bakelite Molded. Either a deep rich brown material or a lustrous black would be especially appropriate and effective for this cabinet and would be sure to find favor with thousands of people whose homes are furnished with antiques or reproductions of the Georgian or late Colonial periods.

The possibilities of Bakelite Molded for radio cabinets of un-

usual and really beautiful designs appear to be unlimited. There is the further advantage that these cabinets, when quantities are sufficiently large, may be produced most economically. We would be glad indeed to discuss these possibilities with radio manufacturers, and to cooperate with them if this is desired.

We also invite you to write for a copy of our illustrated Booklet 13M, "Bakelite Molded".

BAKELITE CORPORATION, 247 Park Avenue, New York, N. Y. 43 East Ohio Street, Chicago, Ill.
 BAKELITE CORPORATION OF CANADA, LIMITED, 163 Dufferin Street, Toronto, Ontario, Canada

BAKELITE

REGISTERED  W. I. PAT. OFF.
"The registered trade marks shown above distinguish material manufactured by Bakelite Corporation. Under the capitol 'B' is the numerical sign for infinity, or unlimited quantity. It symbolizes the infinite number of present and future uses of Bakelite Corporation's products."

THE MATERIAL OF A THOUSAND USES

ELECTRONICS, July, 1935. Vol. 8, No. 7. Published monthly, price 35c. a copy. Subscription rates—United States, \$3.00 a year. Canada, including duty, \$3.50 a year. All other countries, \$4.00 a year or 16 shillings. Entered as second class matter, April 4, 1930, at Post Office at New York, N. Y., under the Act of March 3rd, 1879. Printed in U. S. A. Cable address "McGrawhill, New York." Member of A.B.P. Member of A.B.C. Copyright 1935 by McGraw-Hill Publishing Co., Inc., 330 West 42d Street, New York, N. Y.
 Printed by The Schweinler Press, N. Y.

S. S. WHITE "NOISE-TESTED" RESISTORS

are used

in the SHURE HIGH-FIDELITY
"Wave-Equalized"

MICROPHONES . . .



The SHURE MODEL 77-E HIGH-FIDELITY CRYSTAL MICROPHONE designed for desk mounting. This is one of a number of SHURE BROTHERS COMPANY High-Fidelity models featuring the "Wave-Equalization" principle.

Employing a new principle known as "wave equalization," the Shure Brothers Company of Chicago recently developed a variety of condenser microphones and crystal microphones for which the manufacturer claims exceptional high-fidelity reproduction.

The manufacturer has advised that S. S. WHITE "NOISE-TESTED" RESISTORS have contributed in large measure to the excellent results obtained. These resistors are used for all high-resistance coupling and isolation units in the amplifiers.

S. S. WHITE "NOISE-TESTED" RESISTORS are held to the following exacting noise specification:

"For the complete audio frequency range, resistors shall have less noise than corresponds to a change in resistance of 1 part in 10,000,000."

For high gain amplifiers, aircraft radios and all other radio and electronic equipment from which noise must be as nearly as possible eliminated, S. S. WHITE "NOISE-TESTED" RESISTORS are virtually indispensable.

They are available in the resistance ranges given at the left, and are supplied on order. Each Resistor on such orders is *individually tested*, assuring conformity to the specification quoted above.

**WRITE for DESCRIPTIVE FOLDER
and PRICES**

Then try "noise-tested" resistors in your own equipment and note the difference in performance.

RESISTANCE RANGES

S. S. WHITE "NOISE-TESTED" RESISTORS

Commercial Field

Supplied in the standard range from 1000 ohms to 10 megohms.

Laboratory and Experimental Field

Supplied in values ranging from 10 megohms to 1,000,000 megohms.

The S. S. WHITE Dental Mfg. Co.
 INDUSTRIAL DIVISION

Knickerbocker Building New York, N. Y.

To the Readers of "Electronics"

AN INVITATION

We know it is customary for a new company to make a formal announcement of its entry into the business world—to tell about its product and its equipment, its policies and its personnel. But we're at a loss to put into sufficiently descriptive words the story we'd like to tell you about Superior Tube Co. So, we are asking you to come and see for yourself an infant prodigy—a business organized in November, 1934—that went into production in January this year—and is now shipping many thousand feet of seamless nickel tubing per day to radio tube manufacturers, and in addition, considerable amounts of other fine tubing such as stainless for hypodermic needles.



You'll find much to interest you. A beautifully located, modern factory, 25 miles out of Philadelphia, in one of Pennsylvania's garden spots. The very latest equipment for drawing seamless tubing, much of which we designed and built ourselves. An organization of keen-eyed young men the like of which you seldom see anywhere. You'll see hydraulically controlled draw benches and continuous annealing under exact temperatures which you'll know must produce tubing that is uniform and accurate.

We'll show you tubing of pure nickel .010" outside diameter, with .0018" walls—the bore so small you can't see it with the naked eye—the landing field alongside from which we very soon will make deliveries by 'plane—and much more we are sure will impress upon you the fact that here is a plant and an organization that closely approaches the ideal.

This is your invitation—come and visit with us. We'll be delighted to see you anytime. You don't need to write or 'phone—just come, the first opportunity you have.

Cordially,



SUPERIOR TUBE CO.
Norristown, Pa.



Features like these are "Reasons Why"
for the superiority of

YAXLEY SWITCHES

YAXLEY

"2900" Series
Dual Wave Switch
offers these
advantages..

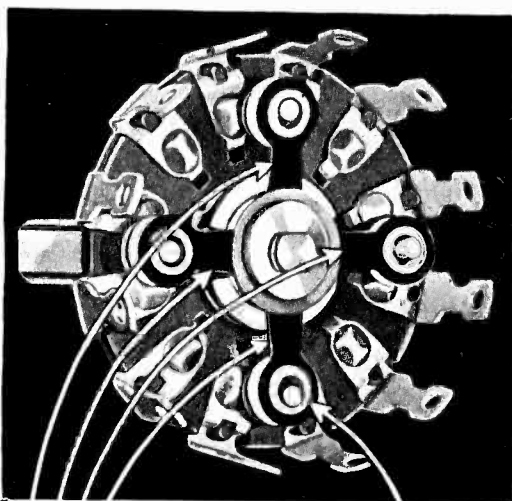

SPRING METAL CERAMIC INSULATION
ROTOR Between Spring Metal
ROTOR and CONTACT SHOE

1 ELECTRICAL

- [a] "2900" has the lowest contact resistance and more uniform contact resistance.
- [b] Silver-to-silver positive contact, definitely wiping in action.
- [c] Insulation of special grade Bakelite and ceramic materials providing imperviousness to atmospheric conditions.

2 MECHANICAL

- [a] It is sturdy, and smooth in operation with perfect indexing action.
- [b] Positive in action.
- [c] Self-aligning, eliminating the possibility of the contact resting between two circuits. In operating the switch, contact point must pass the centre position or it will spring back to original position.
- [d] Neat and compact in size.
- [e] Flexible—can be supplied in any combinations required for dual wave service.

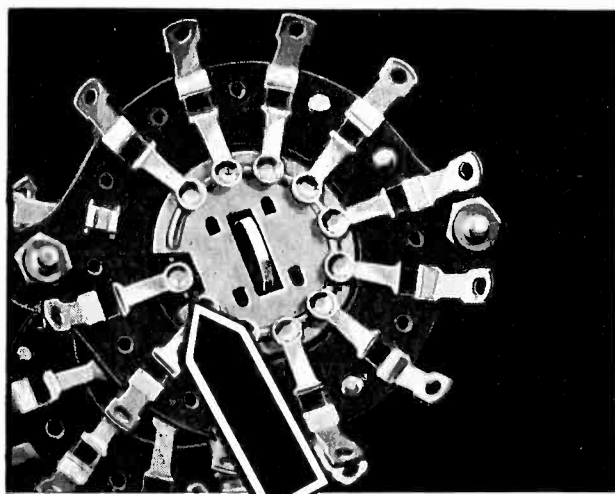

The shorting rotor plate of this switch section short circuits all the coils except the coil in use.

YAXLEY ALL WAVE SWITCHES

are noted for

- 1 Low, uniform and unchanging contact resistance.
- 2 Imperviousness to atmospheric conditions.
- 3 Low capacity to ground.
- 4 Elimination of coil absorption.
- 5 Adaptability of all circuit arrangements.
- 6 Smooth operation with positive indexing action.
- 7 Affords proper shielding of circuits and coils.
- 8 Compactness of design.
- 9 Rugged construction to insure long life.

★ Send a sketch or description of your requirements and samples will be mailed promptly ★

YAXLEY

YAXLEY MANUFACTURING DIVISION
of P. R. Mallory & Co., Inc.
INDIANAPOLIS, INDIANA Cable [Address]: PELMALLO

MALLORY

ORESTES H. CALDWELL
Editor
KEITH HENNEY, Managing Editor

HOWARD EHRLICH
Vice-President

H. W. MATEER
Manager

Money for plant expansion

THE Federal Housing Administration's "modernization" credit plan has now been extended to cover industrial and commercial loans up to \$50,000, for "the purchase and installation . . . of such equipment and machinery, with or without structural changes in the building, as are peculiarly adapted to the business conducted therein or necessary to the operation thereof." Under this plan Uncle Sam stands ready to insure local lenders up to 20 per cent of their total loans.

THERE are many ways in which this new credit can be used for the benefit of radio and the electronic fields. Receiver manufacturers and parts makers now have a source of funds for modernization of their plants. Tube manufacturers will find such loans a welcome aid in the problem of making the new tube types.

Industrial plants can now expand their budgets for new electronic control apparatus, and new tube processes.

INTEREST rates for such accommodations are low. The FHA requires that the total charge shall not be in excess of five per cent on the face amount, or \$5 discount per original face amount of a one-year note payable in equal monthly installments. Notes may not have a final maturity in excess of five years.

The new insurance service does not apply to the purchase of portable items, but any equipment which is "installed" or "attached," or is connected by wire, tube, hose or flue, is included under the terms of the FHA \$50,000 clause. Manufacturers are invited to apply directly to the Federal Housing Administration, which will put the applicant in touch with a source of funds. Each individual property is entitled to a separate loan of \$50,000.

radio
sound
pictures
telephony
broadcasting
telegraphy
counting
grading
carrier
systems
beam
transmission
photo
cells
facsimile
electric
recording
amplifiers
phonographs
measurements
receivers
therapeutics
traffic
control
musical
instruments
machine
control
television
metering
analysis
aviation
metallurgy
beacons
compasses
automatic
processing
crime
detection
geophysics

RADIO ART ADVANCES TOLD AT

New circuits are disclosed for automatic control of frequency and selectivity of radio receivers

RADIO engineers to the number of six hundred were brought up to date in all phases of the radio art, transmission and reception, at the 10th Annual I.R.E. Convention at Detroit, July 1, 2, and 3. For receiving set designers there were papers indicating that future sets may have many more of their important characteristics automatically controlled by the incoming signal. Papers read indicated that both selectivity and tuning may be automatically controlled, perhaps in the 1936 receivers. Transmission engineers heard of the remarkable stability of control effected by the use of concentric tubing, compared to the use of quartz crystals. Much was revealed about the vagaries of the path between transmitter and

receivers, including the exciting identification of the origin of signals coming to the earth-bound receiver from the Milky Way.

While it is expected that the papers given at Detroit will appear in full in the Proceedings of the I.R.E., the following reports of the papers as delivered at the Convention may indicate to some extent the importance of the annual gathering.

New receiver circuits disclosed

Of the many papers, those given by G. L. Beers of RCA Victor and Charles Travis, formerly of the RCA License Laboratory but now of the Philco research staff in Philadelphia, were of the greatest interest to engi-

neers responsible for the design of home and automobile radio receiving sets.

In Mr. Beers' system of automatic selectivity control (ASC) as described in his Detroit paper, tubes are shunted across portions of the r-f and i-f circuits whose selectivity characteristics are to be changed. These shunting tubes operate at a fixed plate voltage; their grid biases, however, are varied in accordance with the incoming signal, and as a result, their plate resistance changes.

In the circuits shown by Mr. Beers, tubes are shunted across the secondary of the antenna transformer, the plate of the ASC tube being connected to the high potential side, of course. This tube varies in internal plate resistance (r_p) between 10,000 ohms and one megohm, producing a range of shunting effects.

ASC tubes are also shunted across primary and secondary of the first i-f transformer, with an additional tube shunting only the secondary of the second i-f. The voltage gain from antenna to first grid varies from 0.75 to 4.4 as the r_p of the first ASC tube changes.

In both antenna stage and first i-f, the reduction in gain and in selectivity occurs simultaneously. In the second i-f, however, the gain increases as the selectivity decreases, for the reason cited below. 16 kc transformers were indicated for coupling between r-f and first detector, and between second and third i-f, and between third i-f and second detector. These were not under ASC control.

The bias for the ASC tubes is secured from a master control tube and an auxiliary control tube. Since the gain is reduced as the selectivity is reduced, some means must be provided for keeping the gain up, otherwise only very strong signals could be received in the wide-band condition. Therefore the second i-f tube is arranged so that its gain goes up (by the action of an AVC diode) as the shunting effect of the ASC tube produces less selectivity. In other

HIGH LIGHTS IN THE CONVENTION PAPERS—

Among the new developments announced at the Detroit convention of the I. R. E. were:

A water-cooled negative-resistance magnetron, capable of delivering 100 watts output at 600 megacycles (G. R. Kilgore, RCA)

Constant-current charts for predicting the operation characteristics of Class C modulated amplifiers (Mouromtseff and Kozanowski, Westinghouse)

Circuits for obtaining automatic frequency control in superheterodyne receivers (Travis)

A gaseous amplifier tube capable of delivering 1 watt of output power with 32 volts on the plate (LeVan and Weeks, Raytheon)

Electron-beam tubes of small dimensions, miniature cathode-ray tubes (H. C. Thompson, RCA)

A new frequency converter tube for "outer grid" modulation (Nesslage, Herold and Harris, RCA)

Ultra-high frequency (65 mc.) equipment applied to telephone plant (Schlaack and Polkinghorn, Bell Laboratories)

Circuits for obtaining automatic control of selectivity in radio receivers (Beers, RCA)

New information on the source of interstellar interference (Jansky, Bell Laboratories)

IRE IN ANNUAL CONVENTION

Recent cosmic and high-frequency data given; new frequency-changer and gaseous amplifier described

words, the control ratio between gain and selectivity is improved. In the receiver made by Mr. Beers, a ten millivolt signal (and above) opens up the receiver to a wide-band condition. To cut down hiss noise introduced by the ASC tube in the r-f stage a delayed ASC arrangement has been employed. No ASC action operates in the r-f tubes until the sensitivity of the receiver has been reduced by the incoming signal to 500 microvolts.

If the listener desires a program from a strong but distant station, while a local station is operating on an adjacent channel, cross talk would occur. A manual adjustment is provided so that the selectivity of the receiver may be increased (but not decreased), thus preventing interference from the local station. In Mr. Beers' circuit seven tubes are required to produce the desired ASC effect. His receiver was provided with a low-pass filter to attenuate all frequencies above 8000 cycles, by 40 db. The output is a push-pull 2A3 stage.

Dr. Travis's paper, read by D. E. Foster of the RCA License Laboratory, disclosed methods of obtaining automatic tuning.

The Travis paper pointed out the necessity of forcing the receiver to be correctly tuned, as was pointed out by S. Y. White in January, 1935, *Electronics* in his paper on "signal seeking circuits." The disadvantages of having high selectivity but poor tuning adjustments are well known. The bad quality of tone, and the fact that on short waves a given station signal may disappear entirely due to oscillator drift are but two of the reasons why the carrier must be accurately tuned in and must stay in this condition.

The Travis circuits are most interesting from the circuit engineer's standpoint. An amplifier whose grid secures excitation from some portion of the i-f system has in its plate circuit a transformer feeding the two plates of a double-diode tube through two secondary windings. There are

two primaries connected in parallel. The secondaries are tuned slightly off the i-f frequency, one slightly above and one slightly below. The primary, however, is tuned to the exact i-f frequency. Between the cathode of the diodes and the return leads of the secondary windings are connected resistances forming a bridge. One end of this center-tapped resistance (cathode to the tap) is grounded and the other end is connected to the portion of the receiver circuit which acts as the frequency control unit. The secondary windings are tuned to frequencies having a separation of approximately F_0/Q where F_0 is the resonant frequency and Q has its ordinary connotation.

The control unit may have several

forms. In each case, however, the variable d-c voltage produced by the double rectifier is used to vary the mutual conductance, or plate resistance, of a control tube as the oscillator frequency is above or below the required resonant frequency. In each case this tube acts as a variable reactance, a capacity for example, shunted across the oscillator tank circuit. In a very simple case the plate resistance of a tube is of the same order of magnitude as the reactance of a condenser placed in series with this tube and the high potential side of the oscillator tank circuit. Variations in the tube resistance produce effective changes in the series capacity which may be thought of as a capacity of different size shunted across

65 MEGACYCLE TELEPHONE LINK DESCRIBED

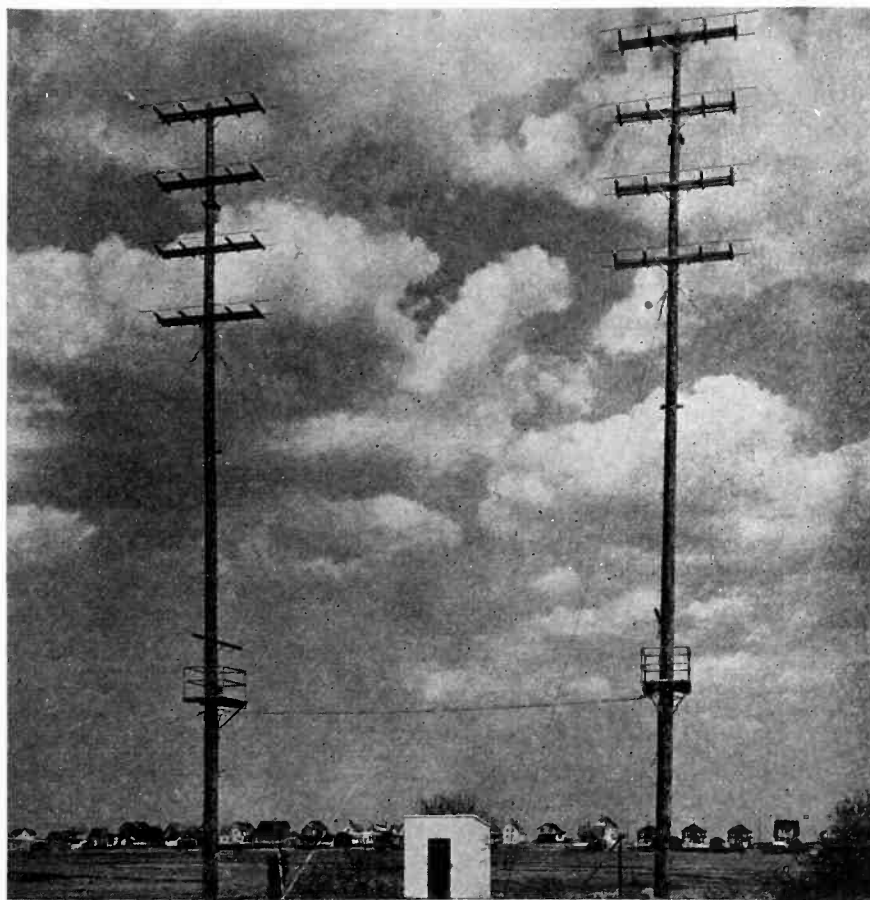

Schlaack and Polkinghorn of the Bell Laboratories described these directive antennas used in the telephone link between Green Harbor and Cape Cod.



Balth. Van der Pol, Jr., recipient of the IRE Medal of Honor, presented at the Convention Banquet

the tuned circuit. Such a circuit is limited in its usefulness to the range of between 1 and 2 megacycles.

Transmitting-tube rating system

R. W. Larson and E. E. Spitzer of the General Electric Company and RCA Radiotron presented a paper, "Transmitting Tube Ratings and Operating Information," which contained many suggestions which have arisen in the I.R.E. Subcommittee on Large High Vacuum Tubes. In their paper the authors displayed a technical information sheet which contained the following items: (1) General Design Data, for use in reference and standardization. This portion contained operating voltages and currents, interelectrode capacitances and physical dimensions of envelope and socket, amplification constant and mutual conductance. (2) Maximum ratings, to prevent unsatisfactory service due to misapplication and overload. Maximum voltage and currents, power dissipation, power output and temperatures are stated in this section. (3) Typical Operating Information to aid in the application and operation of the tube.

The use of charts to record the quality of a manufacturer's output of tubes, as a function of time over a period of months was also suggested. Typical Information Sheets for the 861, 211 and 214 were shown. References for calculating the power output, efficiency, plate and grid dissipation under typical operating conditions were given, so that the In-

formation Sheet might be applied to practical problems in tube application. The paper was not presented as a report of the subcommittee, but rather as an indication of its work, so that suggestions and comments on the paper could be used in furthering the work of the subcommittee.

Short-wave static from the stars

Great popular interest was aroused two years ago when it was discovered that short-wave static picked up by a rotating antenna, showed a maximum when the antenna array was pointed at a certain spot (R. A. 18 hours; D. —20 deg.) in the Milky Way, or galaxy of several billion stars, of which our sun is one. This discovery by Karl G. Jansky at the Holmdel, New Jersey, station of the Bell Telephone Laboratories, received further scientific interest when Mr. Jansky's computations of the spot source in the star-fields of the sky, identified the source of short-wave static with the supposed location of the gravitational center of the Galaxy, as assigned by Dr. Harlow Shapley of Harvard.

The data obtained from Mr. Jansky's pick-up system is in the form of a continuous record of the static radiation for all hours of the day and, since the antenna rotates continuously (once in 20 minutes), for all directions as well. If we examine a typical day's record of the disturbance, for example that for September 16, 1932, besides varying gradually in height throughout the day the peaks

obtained for each revolution of the antenna also change decidedly in shape. From 12 M. to 3 P.M. the peaks are very broad, in fact one peak covers the time taken up by one complete revolution of the antenna. But from 3 P.M. on, the peaks gradually get narrower and narrower, until at 10 P.M. they are only one-quarter the previous width. During the same time a much smaller and weaker peak begins to appear on the record. By 9:30 P.M., however, it is very clear.

Upon determining the direction towards which the antenna system was pointing in space at these times, it is discovered that when the peaks are broad, the antenna is so located in space that it sweeps *along* the Milky Way, and the *maximum response* is obtained when it points in the direction of the *center* of the Milky Way. When the large sharp peaks and the alternate small peaks are obtained, the antenna is so located in space that it sweeps *across* the Milky Way, the large peak being obtained when that section of the Milky Way nearest the center is crossed, and the small peak when that section farthest from the center is crossed.

Ultra-short-wave telephone used on Cape Cod

A paper by N. F. Schlaack and F. A. Polkinghorn of the Bell Telephone Laboratories, New York, was presented on the subject "An Unattended Ultra-Short-Wave Radio-Telephone System." The paper de-

COSMIC STATIC FROM THE MILKY WAY

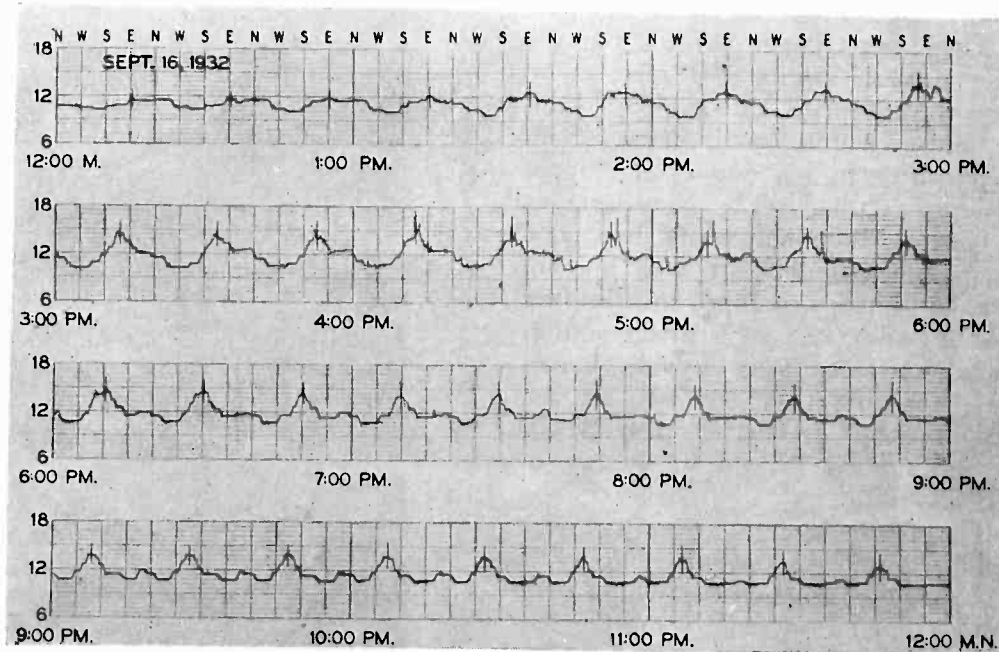

The antenna array rotates once in 20 minutes, and picks up distinct peaks each time it crosses the plane of the Milky Way, the sharpest peaks being noted when the crossing is near the Sagittarius "center" of the Milky Way

scribed the plant equipment used by the New England Telephone & Telegraph Company between Provincetown on the end of Cape Cod and Green Harbor on the mainland of Massachusetts. In this system transmission from Green Harbor to Provincetown is accomplished on a frequency of 65 megacycles and the reverse direction on 63 megacycles. Crystal control transmitters of 15-watt carrier power, capable of 100 per cent modulation are used at both terminals. Privacy equipment is installed similar to that used on the transatlantic short-wave radio telephone channels.

Superheterodyne receivers of the conventional type were used at the receiving end of each terminal, with crystal oscillators as the source of the beat frequency.

One of the most interesting features of the installation is the antenna system used. Transmitting and receiving antennas are identical, each being mounted on a single wooden pole about 90 ft. high. Horizontal polarization is used with four pairs of half-wave rods as radiators and four pairs of similar reflector elements spaced one-quarter wave length on the opposite side of the pole. A gain of over ten times is reported by the use of these antennas over a simple single half-wave element of the same power input.

Class C power amplifiers discussed

The first paper presented in the small meeting room on July 2 was

the work of Mr. I. E. Mourontseff and Mr. H. N. Kozanowski of the Westinghouse Company on the subject "Analysis of the Operation of Vacuum Tubes as Class C Amplifiers." The problem of pre-calculating the output power, efficiency, grid excitation power and other necessary operating data for a tube used as a class C amplifier was stated as the main objective of the paper.

The analysis described is of a graphical nature, making use of what is known as constant-current charts, in which the plates and grid potentials are plotted on two coordinate axes, for constant values of plate current. This type of representation is particularly useful because first it provides plate and grid characteristics on one chart, despite the difference in magnitude of these voltages; second, the operating point is located in terms of applied voltages (plate and grid) at a single point on the graph, and third, the dynamic characteristic for operation as an amplifier (either class A, B or C) is represented by a straight line.

The method of determining the operating conditions of the tube consists in determining the operating plate voltage, the operating grid bias voltage, and the maximum grid swing. With these three values known the dynamic characteristic of operation can be plotted on the graph directly as a straight line. On the basis of this curve and other measurements made directly from the graph the power output can be determined from a simple geometrical substitution, as can the



F. B. Llewellyn of the Bell Laboratories, who received the Morris Liebmann Memorial Prize at Detroit

efficiency and the optimum load resistance require. By using a grid current-time curve the grid excitation power can be calculated readily. The discussion continued with the case of the modulated class C amplifier using the same general method under the condition of varying grid excitation and with various bias methods.

Kilgore describes magnetron oscillators

The first paper in the afternoon of Monday, July 1, was read in the small meeting room by Mr. G. R. Kilgore of the Radiotron Division of the RCA Manufacturing Company on the subject "Magnetron Oscillators for Generating Frequencies from 300 to 600 Megacycles." In order to obtain high output on these frequencies the oscillation generator must have a fairly high efficiency and a high anode dissipation. The paper discussed one of the most promising generators for this purpose, the negative-resistance magnetron oscillator.

The negative-resistance magnetron oscillator is one which operates by reason of a negative-resistance characteristic of the tube itself, the frequency and oscillation being determined by circuit constants. The negative-resistance characteristic of the tube has been studied by plotting the difference of the current to the two halves of the anode as a function of the difference of voltage between the two anode halves, and this characteristic has been used in the calculation of output efficiency and optimum load resistance. The study indicates that high efficiency may be expected from this type of device and

HIGH POWER MAGNETRONS AT 600 MEGACYCLES



G. R. Kilgore of the RCA Radiotron Division with his laboratory set-up of negative-resistance magnetrons, described in his paper at Detroit



G. L. Beers, who revealed important circuits for automatic control of selectivity

that the optimum load resistance is of reasonable value.

From the analysis it has been shown that high efficiency can be obtained by the use of a small anode diameter and high plate voltage. For frequencies of the order of 600 megacycles, a diameter of .5 cm. and a voltage of 1,500 are required. An experimental tube capable of dissipating more than 200 watts and of delivering a useful output of 100 watts at 600 megacycles was described.

Vacuum tube design

G. D. O'Neill of the Hygrade Sylvania Corporation delivered an interesting paper on "Some Theoretical Considerations Relating to Vacuum Tube Design." According to Mr. O'Neill, in designing vacuum tubes it is the usual plan to use, where possible, parts standard to other types already in production. The designing then consists largely in determining the dimensions of elements which, with the standard parts to be used, will result in a tube of the desired electrical characteristics.

The final design of a tube cannot generally be made until sample tubes having almost exactly the right characteristics have been made. The working out of the data is accomplished in one or more successive steps, each step being a new computation based on experimental data.

In computing the dimensions of parts for the first set of experimental tubes, where there are no experimental data on tubes nearly like the desired tube, data may be obtained from tubes of even considerably dif-

ferent construction and electrical characteristics which may be used as a starting point for the new design.

The method of designing a triode was given, and the equations were developed. An example was then given of the use of the equations in designing the grid of a triode where the cathode and plate dimensions are predetermined because they are in use in other tubes, the characteristics of the new triode having been previously decided upon.

WBT antenna tests reported

Comparative tests on a mast-type vertical antenna and an L-type antenna used at station WBT in Charlotte, N. C., were reported by S. S. Kirby of the Bureau of Standards in his paper, "A Study of Radio Field Intensity vs. Distance Characteristics of a High Vertical Antenna at 1,080 kc." During the changeover from a T antenna to a vertical mast at this station, automatic field strength measurements were made at seven locations, varying in distance from 69 to 879 km. from the transmitter. The conclusions drawn from the experiments are: That low-angle radiation (less than 45°) was increased from 1.5 to 2 times by the substitution of the mast for either the L or the T type; that the ratio of high angle to low angle radiation was decreased, although the absolute value of the high-angle radiation may not have been decreased; that the maximum sky-wave intensity and maximum fading with either antenna occur at the same distance, namely, 500 to 600 km. The practical results of the installation of the mast antenna were to increase the field intensity and decrease the fading within a radius of approximately 100 miles, and to increase the field without decreasing the fading, over greater distances. It was pointed out that these conclusions cannot be taken as general for all installations of this type, since substantially different results might be obtained at different frequencies, and with different ground conditions surrounding the antenna.

Gas-filled amplifier

In the gas-filled tubes reported on by J. D. LeVan and P. T. Weeks of Raytheon an auxiliary grid is introduced to act as an anode for an arc discharge and at the same time as a virtual cathode for the main electron stream which is controlled by a grid just as in a high vacuum tube.

These gas-filled amplifiers resem-

ble the grid-controlled, mercury-vapor rectifiers of the Thyatron or grid-glow types except that the control grid has complete modulating or control ability over the plate-current flow. In the tubes discussed in this paper, high amplification is combined with low-plate resistance to produce a high value of mutual conductance. For example, one tube (RK-100) has a mutual conductance of 12,000 micromhos with an amplification factor of 50. This tube draws 150 m.a. in the arc at 100 volts on the plate and minus 2.5 volts on the grid.

The authors discussed applications of these low-impedance tubes. Operating on low-plate voltages they produce considerable power output. For example, a tube operating from a 32-volt plate supply produced 0.9 watts output of audio power into a 230-ohm load.

Other tubes constructed in the Raytheon laboratory are screen-grid tubes with high impedance and high mutual conductance. One such tube had an amplification factor of 925 and a mutual conductance of 7,466 micromhos.

The RK-100 has been used as a Hartley oscillator with low-plate voltages producing appreciable power.

A new frequency conversion tube

One of the authors (W. A. Harris) of a paper describing a new five-grid tube with applications to frequency changing, r-f amplification, or in other circuits where double-control grid tubes are useful, delivered a paper at the Fall Meeting in Rochester in 1934 and laid the groundwork for the present paper given in Detroit. Troubles with the frequency conversion system have been well known and, it is hoped, have been solved by means of the new tube (6L7) described by C. F. Nesslage, E. W. Herold and W. A. Harris of RCA Radiotron.

The new tube contains five grids as follows:

- No. 1—Remote cut-off r-f signal or control grid.
- No. 2—Screen grid similar to that of existing tubes.
- No. 3—Oscillator or modulator grid of high amplification factor.
- No. 4—Screen, internally connected to No. 2, to raise the plate resistance.
- No. 5—Suppressor grid; connected internally to cathode.

This tube, known as an "outer-grid modulation" tube was reported by the authors to have the following advantages: an increased gain at 20 megacycles; easier alignment of the tuned circuits because of decreased reaction between r-f and oscillator circuits; higher plate resistance and resultant greater selectivity; greater oscillator stability due to the decreased oscillator power requirements; operation over a wider range of frequencies; for example, at 60 megacycles the tube produces good results, although the present 6A7 and similar tubes do not operate well above 40 Mc.

A most interesting application, presented by the authors, is the possibility of using this tube in a volume-expansion circuit (see *Electronics*, June, 1935, in which W. N. Weeden presents a circuit for volume expansion). Special uses with phonograph music were indicated. The tube may also be used as a straight r-f amplifier.

New electron-beam tubes

Under the general title of "Electron Beams and Their Application in Low Voltage Devices," H. C. Thompson of RCA Radiotron Division discussed his research on the properties of electron beams in envelopes of the size of receiving tubes and under the propulsion voltages of the order of those used in receiving circuits. The preliminary study was made by means of the visible traces of beams of electrons impinging on electrodes coated with luminescent material or by means of glows in suitably low pressures of gas.

Mr. Thompson stated that the openings of thin structures, such as grids, placed in the electron stream, even under space-charge-limited conditions, act like converging or diverging lenses with respect to the stream according to whether the structures are below or above space potential respectively. At space potential the luminescent traces on an anode indicate that approximately geometrical shadows of the structures are formed and that there is neither appreciable convergence nor divergence of the unobstructed part of the electron stream.

Among the structures tested by Mr. Thompson have been those employing a screening electrode which receives negligible current; those in which a control grid operating over a positive range receives a current radically reduced from that commonly obtained; those in which the

transconductance to one anode becomes practically zero over a certain range and its former value is transferred to a second anode; those in which an electrode has a negative impedance depending neither upon secondary emission nor upon its coupling to another electrode.

By means of the systematic segregation of the space current into beams and by the appropriate shaping and registry of the members of successive electrodes, a new set of characteristics has been made available in electron discharge devices.

Ultra-short-wave propagation

On Wednesday morning the paper on "Ultra-Short-Wave Propagation Over Land" by C. R. Burrows, Alfred Decino and L. E. Hunt of the Bell Telephone Laboratories was presented. This paper contains the latest advances in the theory of ultra-short-wave propagation, based on the theory of physical optics. This theory proceeds from the assumption that the energy of ultra-short-wave (from 30 to 200 megacycles) can be reflected from the surface of the earth, and that in general the wave received at an antenna consists of a direct component and a reflected component whose vectorial sum determines the strength of the excitation of the receiving antenna. Thus, as the receiving antenna height is increased the signal decreases and then increases to a maximum, finally falling off to a second minimum. The maximum corresponds to the point at which the

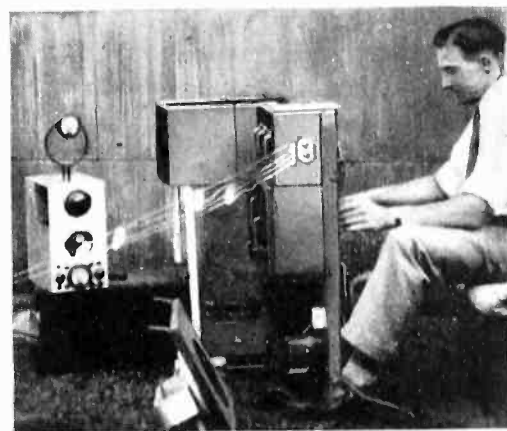

Alfred Decino with equipment for measuring uhf field strength used in propagation studies

reflected and the direct waves arise in phase, the minima to those heights at which they arrive out of phase.

In checking this theory measurements were made in specially chosen localities in New Jersey, over the most level ground which could be found. The observed variations in signal strength with changes in height of the receiving antenna approximated very closely the predicted theoretical variation. The portable equipment is capable of being set up in an hour's time.

The experimental results indicated that the received signal strength can be represented by an equation of the form

$$E = kh$$

h is the height of the antenna, k is a constant and E is the received field strength.

CONCENTRIC TUBES FOR FREQUENCY CONTROL



C. W. Hansell as he appeared before the Convention, describing a high Q concentric line, a portion of which is shown at the left

ELECTRONIC ENGINE INDICATORS

By Ivan Bloch, E. E.

—a new use for tubes

ONE of the most comprehensive representations of the operating characteristics of thermal engines is the so-called PV and PT diagram, also known as the engine indicator diagram. From such diagrams, which represent the actual thermal cycles, the technician can determine with certainty the characteristics of compression, combustion, exhaust, intake, etc.

The component parts of engine indicator mechanisms comprise means for recording the pressures within the cylinder, for simultaneously obtaining the volume or time variations and means for observing these quantities as coordinated functions. In steam technique, the indicator dates to James Watt (1790) and since then its application to almost every type of thermal engine has resulted in an enormous variety of instruments. (1, 6)

Problems of engine indicators

Engine indicators as a whole suffer from a multitude of design and operating factors which render each type of instrument one for specialized study. Some such factors are faults in the volume or time displacement mechanisms, extreme sensitivity to extraneous vibrations, lack of sensitivity due to inertias of the pressure recorder at high engine speeds, inaccuracies due to wear of various parts, temperature effects, etc. In spite of these difficulties, the engine indicator has been highly refined and in the hands of the trained diagnostician has been invaluable in the development and operation of thermal engines.

Electrical engine indicators are not numerous. It is only recently that work has been done on electronic indicators, where, for example, the visual coordination of pressure, time or volume variations has been accomplished by means of the cathode ray tube. At the present time, no instrument is available which will allow for the commercial testing of engines with sufficient simplicity, flexibility and simple technique.

ELECTRONIC INDICATOR CARDS

The pressure-volume diagrams, or "indicator cards", of expansion engines are the most effective devices for analyzing engine performance. In this article are described several ways in which these diagrams may be traced on the screen of a cathode ray tube, a system which possesses several advantages over the older mechanical methods now in general use.

The electronic arts offer distinct advantages towards the solution of many problems of engine indication. There is little doubt that the subject itself has been neglected by the electrical engineer and particularly by those familiar with electronics. By pointing out the general requirements of an electronic engine indicator and briefly outlining the work done, it is to be hoped that interest will be stimulated.

Electronic indicator system

The component parts of an electronic indicator system comprise a cathode ray oscilloscope and power supply, a pressure recording device and its associated circuits, availing proper deflecting voltages to one pair of plates, the

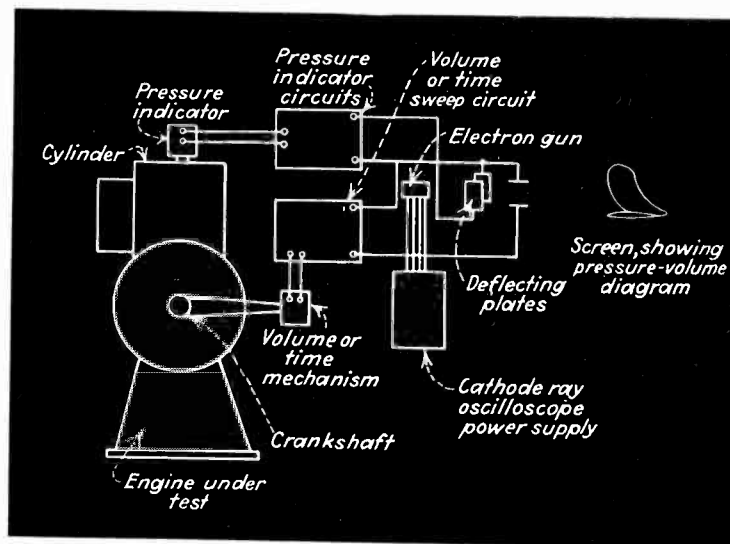

Fig. 1—General layout of engine, pressure indicator and cathode-ray tube

time or volume sweep circuits and mechanical adjuncts for deflections of the other pair of plates. The general requirements of each follow.

As engine speeds vary from idling to high, the cathode ray tube screen must be of persistent fluorescence, preferably of the time-decay type where persistence is obtained by anode voltage interruption. At low speeds, the slowly-moving electron beam will leave a clearly visible trace, whilst at high speeds, the pattern will show all rapid variations. Furthermore, the screen material must be chosen, if necessary, for high actinic content for photographic recording. Provisions may be made for screen surface calibration or the placing of transparent diagnostic charts. The power supply must be stable, rugged and free from output voltage variations.

The pressure recorder offers the greatest difficulties. It must respond accurately and continuously to pressure variations. Thus it must be free from inertia, hysteresis and temperature effects. It must add negligible volume to the cylinder clearance and if fitted into the cylinder

must not alter the contour of the cylinder head from its normal operating conditions so as to prevent abnormal turbulence of the gases within. If tubes are used to connect the recorder with the cylinder, consideration must be given to pressure surge impedances of the tubes themselves. It is obvious that the device must be mechanically

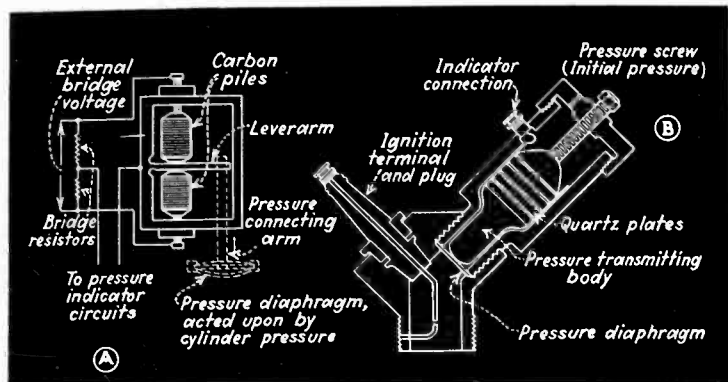

Fig. 2—(A) Carbon-pile pressure indicator. (B) Piezo-electric pressure indicator, showing ignition plug

rugged, simple and fool-proof, easily placed in position and sufficiently low in cost so as to allow for the use of several units per engine.

The simplest pressure recorder is the so-called carbon pile telemeter.^(7, 8) It consists of two piles of optically-ground carbon wafers or disks. These piles are so connected mechanically that changes of pressure, whether positive or negative, compress one pile and expand the other. The piles are made part of a Wheatstone bridge circuit. The assembly is very neat and fitted with correct ignition terminals, the whole threaded and to be used in place of the regular spark plug. This device, however, has many disadvantages. The available output or resistance variations are not large enough for proper deflections of the cathode ray oscilloscope; hence its use has been restricted to mirror-type oscillographs. An amplifier can be used but adds to shielding complication. The carbon piles vary in resistivity with temperatures which must either be taken into account in the diagnosis of the resulting diagrams or the temperature effect made as negligible as possible. In some commercial telemeters, provisions are made for compressed air cooling. A third factor is that a certain amount of hysteresis takes place. The cost of the assembly is rather high. In spite of the above difficulties, excellent results have been obtained, although for quantitative observations, an elaborate calibration is necessary.

Quartz-disc type

Another type of pressure recorder makes use of the piezo-electric effect.^(3, 4, 5) Instead of carbon wafers, quartz disks are used which are subjected to the pressures within the cylinder; variations of these pressures cause changes of the charges on the quartz plates. The output of the assembly is used in a vacuum tube bridge. Characteristic difficulties render its present use somewhat limited. Although its sensitivity is greater, it possesses the same general inherent faults of the carbon-pile telemeter. Careful shielding is necessary, particularly for engines requiring electrical ignition.

An obvious type of pressure indicator comprises a small diaphragm or combinations thereof in which cylinder pressure variations result in proportional changes in the capacity of a condenser in which one plate is the diaphragm.⁽¹⁾ This effect is used either in a bridge circuit

or in a semi-resonant circuit. However, the diaphragm must be calibrated and replaced frequently, and offers various resonant-peak problems.

It must be noted that with the advent of the "acorn" type tubes, some of the electrical limitations of the pressure recorders described above may be obviated. By building one or several stages of amplification integrally with the device, an increase of sensitivity is gained.

The timing sweep is not as simple as might be expected. In the case of pressure-time diagrams, it is preferable to have the timing cycle the same as the thermal cycle in duration. This means that an arbitrary timing circuit cannot be used, for should the engine operation be not smooth rotationally or rapid variations in speed take place, uniform timing will distort the true engine conditions as observed. Thus some mechanical connection is required to control the frequency of the timing sweep. The simplest method which immediately suggests itself is the use of a variable resistor directly connected to the crankshaft. As the crankshaft rotates through a full revolution, the wiping contact would increase the available resistance linearly from a minimum to a maximum. However, there are no methods of construction which will allow continuous rotation without serious wear of contacts and resistive elements, unless a commutator device is used with proper filters to smooth the resistance-step effects. Such a commutator device is bulky if the resistance steps are made small enough to result in a smooth resistance curve and hence steady deflection impulses. An alternate method is to drive a variable condenser from the crankshaft, or an inductance, thus varying either a semi-resonant circuit or a bridge circuit.

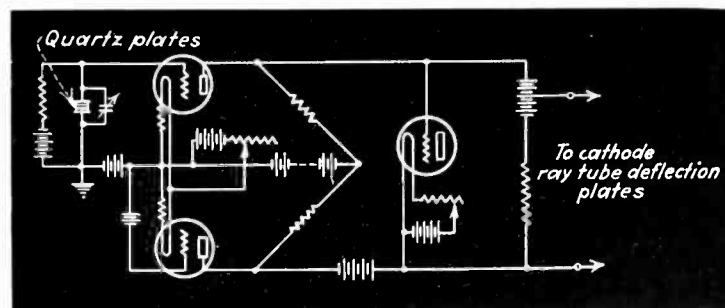

Fig. 3—Circuit used with piezo-electric pressure indicator

Using the usual electrical sweep circuit of the relaxation type does not complete the requirements. Manual operation of the frequency (time) shifts is necessary for various engine speeds. This may be done automatically in the following manner. The crankshaft operating through a small inertia-type governor increases or decreases the value of the variable condenser in the relaxation circuit. The method is not entirely satisfactory due to the lack of sensitivity of the governor to rapid speed fluctuations. Furthermore, if a large range of speeds is to be encountered, the values of the variable condenser's capacity become too extreme. A compromise lies in the use of speed range switching and fine frequency control through the governor-regulated condenser.

Pressure-volume diagrams require a sinusoidal sweep deflection, unless a mechanical link system transforms the constant angular motion of the crankshaft into the simple harmonic deflections which volume variations represent. Generally the difficulties are the same as for the previous sweep circuits mentioned above. In this case, however, the resistor should increase sinusoidally to a maximum and then decrease likewise, which necessitates

[Please turn to page 223]

High resistance measurement with vacuum tubes

By ALBERT PREISMAN

R C A Institutes, New York City

ALTHOUGH almost every characteristic of the vacuum tube has been exploited in some circuit or other, hardly any use has been made of a tube operating with a "free" or "floating" grid. Recently, however, a patent has appeared in which this mode of operation is described for the purpose of measuring resistances, particularly those of one hundred megohms or more. (See U. S. Patent 1,966,185.)

The basic circuit employed is shown in Fig. 1, and it is to be observed from this figure that a positive potential, E_g , is applied to the grid through the unknown resistance R_x to be measured. The readings are made in the plate circuit, where a milliammeter serves to indicate by the value of plate current, the magnitude of R_x .

If R_x is infinite in value (open circuit), the grid becomes "free", or insulated from the cathode, except for leakage resistance in the tube base, socket, and connecting wires. The potential acquired by the "floating" or "free" grid is negative with respect to the cathode (in modern, hard tubes), and is due to the electrons emitted and projected from the cathode onto the grid.

In the early days of the art the plate current for "free" grid was by no means uniquely defined, and peculiar loops were obtained when the grid was varied from its "free" potential. These effects, however, were shown to be due to ionization of the residual gas, and are practically non-existent in modern hard tubes.

For finite values of R_x , the grid discharges through R_x , and the polarity of the battery E_g is such as to aid the grid in doing so. As a result the grid is rendered less negative by E_g for some value of R_x than if E_g had not been inserted in the grid circuit, and the increase in

BY THE USE of a "free-grid" method, a vacuum tube can be made to measure resistances as high as 1000 megohms. This article describes a simple a-c operated form of electronic ohmmeter

plate current for the given finite value of R_x is greater. In other words, the sensitivity of the device is increased by the use of E_g . We thus have a sensitive means of measuring resistances ranging from infinity to some low finite value determined by the full scale reading of the plate meter.

Meter calibrated from standards

An analytical derivation of the action of the tube under the above conditions is very difficult because of the non-linearity of the grid-to-cathode resistance, and also because of the initial velocities of the electrons emitted from the filament, which velocities follow Maxwell's Law of Distribution. Suffice it to say that an empirical relation may be found between R_x and the plate current for any value of E_g , which relation may be used to calibrate the plate meter scale in resistance units.

A suggested setup uses a type 40 tube with 90 volts on the plate, approximately 1000 volts in the grid circuit, and a 0-1 milliamper plate meter. Such a device will read up to 1000 megohms and higher. If the plate circuit be set up (such as in bridge fashion) so that the plate meter reads only change in the plate current, E_g may be considerably reduced, or else higher values of R_x measured, or both.

The use of a vacuum tube allows alternating current to be used for the energizing source, since the grid can act both as a rectifying and control element. In this manner high values of E_g are easily obtained, and this adaptation is particularly well suited for commercial

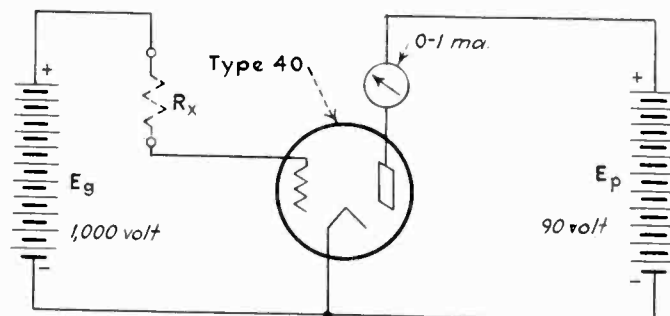

Fig. 1—The fundamental ohmmeter circuit, which can be used to measure resistances as high as 1000 megohms or more

use. Figure 2 shows such a circuit. A portion of the secondary is tapped off for plate supply, and any one of three values of grid voltages may be applied by means of selector switch S_1 . Selector switch S_2 allows either a known, calibrated resistor R_0 to be placed in the grid circuit, or the unknown resistance R_x . It will be noted that rectification occurs simultaneously in the plate and grid circuits, and that the device functions only during each positive half cycle.

Since R_x may have capacity associated with it, as in the case of a cable, it is advisable to have a condenser C (shown in dotted lines) connected so as to reduce the effect of the additional capacity of R_x to a minimum. If the condenser C is large enough, it will charge up to the peak grid voltage, and hold the grid voltage to this maximum value until the next positive half cycle. Obviously, the additional capacity of R_x can have little further effect. Since the values of R_x usually measured are of the order of megohms, C can be of small value and yet produce the above desired effect, since the time constant of the grid circuit is so high due to the high value of R_x .

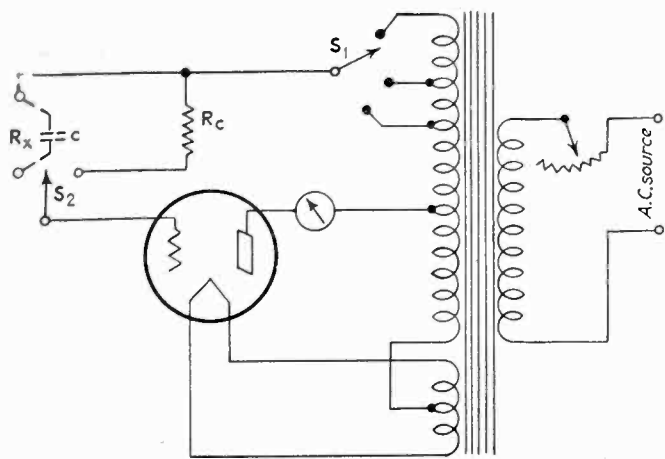

Fig. 2—An a-c operated form of the ohmmeter, which eliminates the necessity of a high-voltage grid bias battery

The device may be rendered practically independent of tube and voltage variations. It has been found that the relation between the plate current and R_x is practically the same for all tubes of the same type, so that if the curve of plate current versus R_x for one tube is matched to that of another tube at, let us say, the extreme ends of the resistance range, the curves will coincide at practically all intermediate points. In order to match the curve for any tube to, let us say, the standard tube, a "free" grid reading is taken for the replacement tube. This corresponds to the infinity point of the scale. If the plate meter does not read infinity, it is adjusted to do so. A simple way to do this is to adjust the zero-correction screw on the meter. Then selector switch S_2 (Fig. 2) is set so that R_c is placed in the grid circuit. The pointer should now read on the proper mark on the scale corresponding to this value of resistance. R_c is chosen so that this mark is near the full scale reading of the meter. If the meter reads incorrectly, the grid voltage is adjusted until it reaches the proper value. (In practice, a rheostat in the primary circuit of the transformer is adjusted, but the results are practically the same as if only the grid voltage was adjusted.) This latter adjustment has no effect upon the "free" grid reading, and so the curve for the tube is made to coincide at its two extremes with that of the original tube. Then, as stated above, intermediate points on the two curves will coincide, too. A further check on the "free" grid reading is generally advisable, particu-

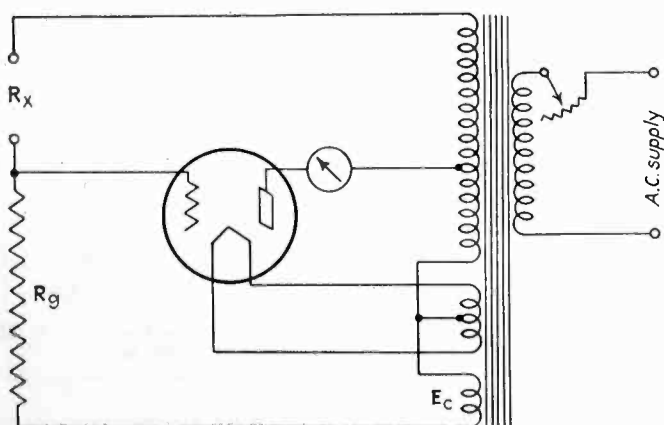

Fig. 3—In this form of circuit, the current flow through R_x is alternating. It is particularly suited to measuring the resistance of electrolytes, since no polarization can occur

larly since all the secondary voltages have been affected by the primary rheostat, but very little time is required to make the entire series of adjustments.

In a similar manner, variations in line voltages can be quickly corrected by switching in R_c at any time, such as before and after taking a reading on R_x , and adjusting the primary rheostat so as to obtain the correct reading for R_c on the plate meter. Actually the adjustments take less time than is required to describe them.

Selector switch S_1 permits various values of grid voltage to be applied for various ranges of R_x : the lower the range of R_x , the lower the value of E_g .

Two interesting variations on the basic circuit of Fig. 1 are possible. The first of these is shown in Fig. 3. It will be noted that the grid in this circuit is no longer "free" due to the presence of R_g . However, the voltage E_c has the proper polarity to impress a negative potential on the grid when the other secondary potentials are positive. Due to R_g , the current flow through R_x is essentially alternating in character, and thus, if R_x is an electrolyte, polarization is prevented.

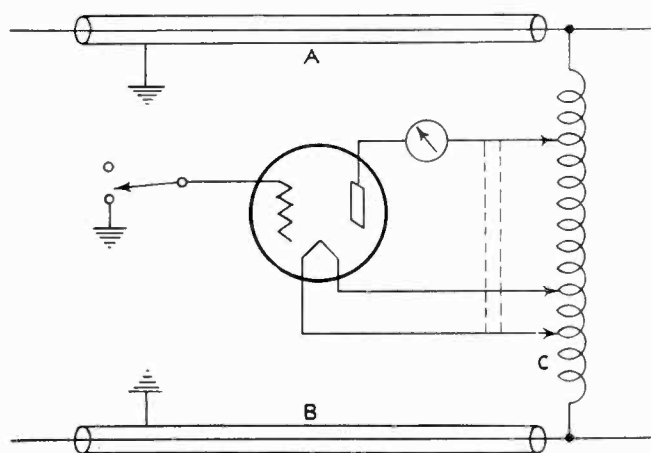

Fig. 4—Set-up for detecting the presence of grounds on either of two power cables

The second variation is shown in Fig. 4, and represents a method of detecting incipient grounds on an ungrounded power system. A and B represent the lead-sheathed ungrounded power cables, and C , a tapped autotransformer connected across them. Plate and filament supply is obtained from this autotransformer, and, as shown, the plate and filament of the tube can be placed at a potential nearer to A , or nearer to B . The grid of the tube is normally grounded, and the filament and plate so set on the autotransformer, that during the half cycle when the plate is positive with respect to the filament, the latter is positive with respect to the grid by the amount of the normal "free" grid potential. When this condition obtains, there will be no change in plate current whether the grid is grounded or left perfectly "free," that is, disconnected from ground and everything else. Now, should an incipient ground develop on A , the grounded grid will move nearer to A in potential, while the filament (and plate) remain at the same potential with respect to A , as well as B . As a result, the plate current will increase. On the other hand, should an incipient ground develop on B , the plate current will decrease. In this manner, a ground can be detected on either A or B , and the magnitude of the change in plate current is a measure of the decrease in insulation resistance of either cable.

Electrolytic capacitor testing in production

By PAUL MACKNIGHT DEELEY

Chief Engineer, Electrolytic Division
Cornell-Dubilier Corporation, N. Y. City

THE radio receiver manufacturer who buys electrolytic capacitors in bulk will find that a slight investment in capacitor test equipment of his own will be well worth while. His own engineers can easily assemble and calibrate the necessary parts, most of which are already on hand. A means of measuring capacitance is especially desirable, as glued labels have an annoying habit of falling off and rubber-stamped figures frequently are smudged by workers' fingers.

Direct current leakage is measured by applying rated voltage to the capacitor through a milliammeter. This is a conventional procedure, the set-up shown in Fig. 1-A being typical of factory practice. Two milliammeters are provided, one for initial high leakage currents and the other for lower stable leakage values after the capacitors have assumed normal lower leakage characteristics.

Impedance vs. bridge methods

Capacitance measurements may be made by two methods: the impedance method, using a voltmeter and an ammeter, and the bridge method. The first method con-

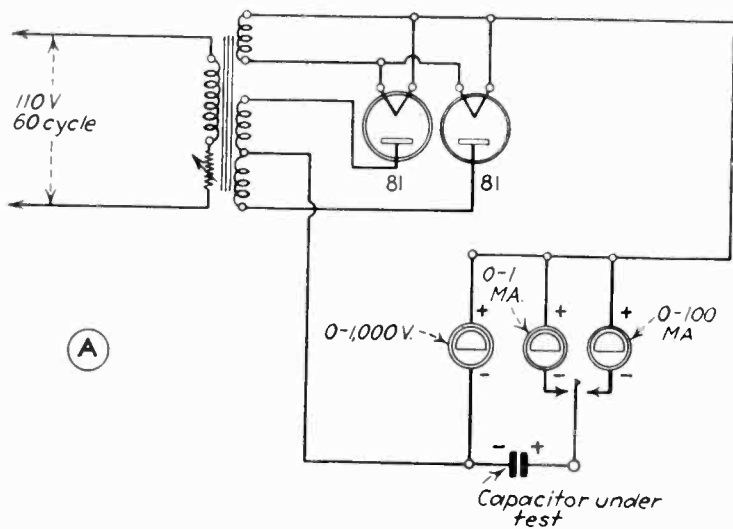

Fig. 1.—(A) The d-c leakage test, for testing at rated voltage. (B) The impedance test for determining the capacity of the condenser under test

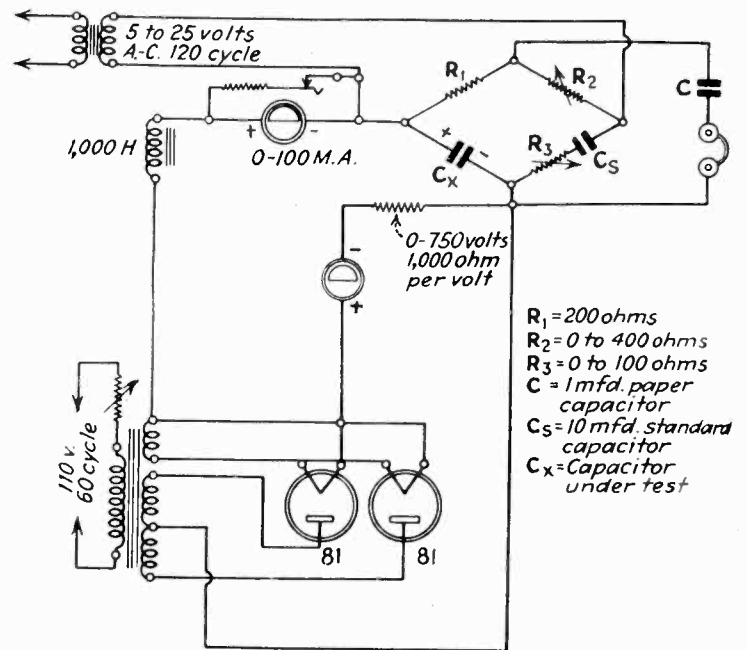

Fig. 2.—Bridge method for testing leakage and capacity. D.c. must be applied to the condenser to prevent unilateral conduction

sists of passing an alternating current through the capacitor under test and a standard mica or paper dielectric capacitor connected in series with it. From the measurement of this a.c. the capacitance is calculated with the aid of the following formula:

$$C_x = \frac{IC}{2\pi f EC - I}$$

C_x = capacity of electrolytic capacitor in farads
 C = capacity of standard capacitor in farads
 I = alternating current in amperes
 E = alternating current voltage across the two capacitors in series in volts.

If the voltage E is kept at a fixed value the formula can be simplified and a chart made showing current I against capacitance.

In the measurement of capacitance by any method, a d-c polarizing voltage should be maintained on the electrolytic capacitor. This should exceed at all times the peak value of the a-c measuring voltage. This must be done to prevent the anode from becoming negative in relation to the electrolyte. A typical circuit network for

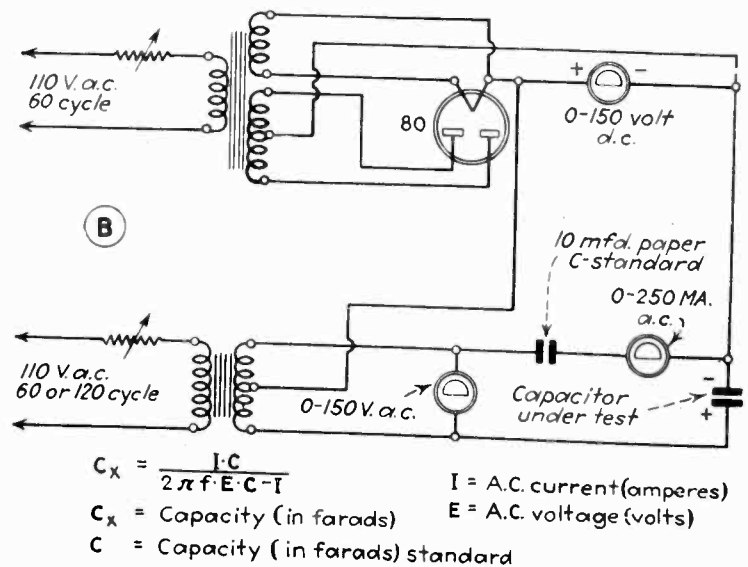

$$C_x = \frac{I \cdot C}{2\pi f \cdot E \cdot C - I}$$

I = A.C. current (amperes)
 C_x = Capacity (in farads)
 C = Capacity (in farads) standard
 E = A.C. voltage (volts)

the impedance method of capacitance measurement is shown in Fig. 1-B.

A capacity bridge that measures capacitance, equivalent series resistance and leakage current is shown in schematic form in Fig. 2. The two variable resistor arms can be directly calibrated so that one (R_2) reads capacitance direct while the other (R_3) reads equivalent series resistance direct. When the bridge is balanced to indicate a null point on the indicator the following relation exists:

$$\frac{R_1}{R_2} = \frac{C_x}{C_s} \quad C_x = \frac{R_1}{R_2} \times C_s$$

C_x = electrolytic capacitor under measurement
 C_s = standard mica or paper dielectric capacitor

Both R_2 and R_3 must be adjusted to reach a balanced condition. The resistance indicated at R_3 , when balance is obtained, is the equivalent series resistance of C_x . In using the bridge method it is recommended that rated d-c operating voltages be maintained on the electrolytic capacitor. A pair of phones may be used as an indicator, but for accuracy it is recommended that the phones be preceded by a two-stage a-f amplifier.

In the use of the capacitance or impedance bridge it is important to remember that if an accurate determination of the equivalent series resistance is to be obtained, capacitance must be balanced against capacitance; that is, the capacitance of the standard should be equal or almost equal to that of the capacitance being determined. When such is the case, the resistance inserted in series with the standard capacitor to reach a null point is equal to the equivalent series resistance of the capacitor under measurement.

If a type of bridge network is used where the standard capacitor is a fixed value and resistance arms are varied

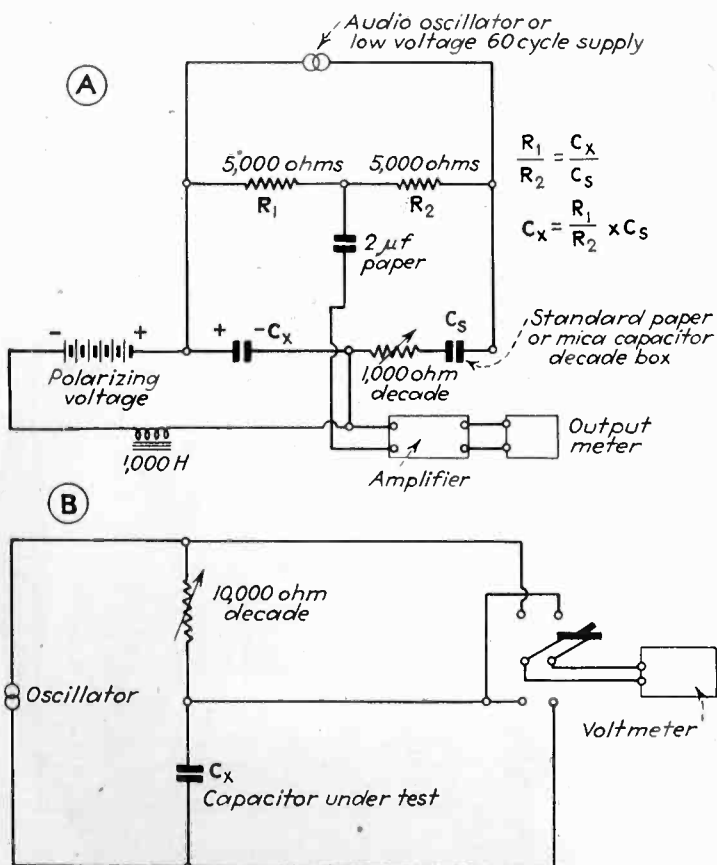

Fig. 3.—Two alternative testing schemes. (A) is similar to the bridge circuits of Fig. 2 but uses an audio amplifier. (B) shows the voltage comparison method, using a VT voltmeter

TESTING ELECTROLYTICS

Radio set manufacturers will find that testing the capacity and leakage of electrolytic condensers is a worthwhile procedure. This article outlines several practical methods of testing electrolytics in production.

for balance, then consideration must be given to the matter of correcting for equivalent series resistance reading, otherwise indicated resistance values may be erroneous to the extent of the ratios of the two capacitances; i.e., that of the standard and that of C_x .

In the diagrams shown, the capacitance determinations, when the bridge is balanced, are equal to:

$$\frac{R_1}{R_2} = \frac{C_x}{C_s} \quad C_x = \frac{R_1}{R_2} \times C_s$$

but unless capacity is balanced against capacity then a correction factor such as:

$$\text{Equivalent series resistance} = R \left[\frac{C_s}{C_x} \right] \text{ must be used.}$$

In Fig. 3-A is shown another form of bridge circuit which may be used in place of the one just described. If the indicated 60-cycle current source is replaced with an audio oscillator, capacitance and resistance measurements may be made at various frequencies.

If it is desired to measure the impedance of an electrolytic capacitor directly, the circuit of Fig. 3-B will serve the purpose admirably. This diagram is self-explanatory.

Figure 4 shows an arrangement recommended for the rapid measurement of capacitance and leakage. The capacitance is measured by the impedance method on a Weston microfarad meter, which must be recalibrated to take into account the series capacitor indicated as the blocking capacitor. The capacitors are placed on rated voltage and allowed to age. High leakage and dead shorts are indicated by the lighting of the 10-watt lamp. The plug is placed under the clip jack with the correct polarity relation. With the switch key in position *L* leakage is read and in position *C* capacitance read on the microfarad meter.

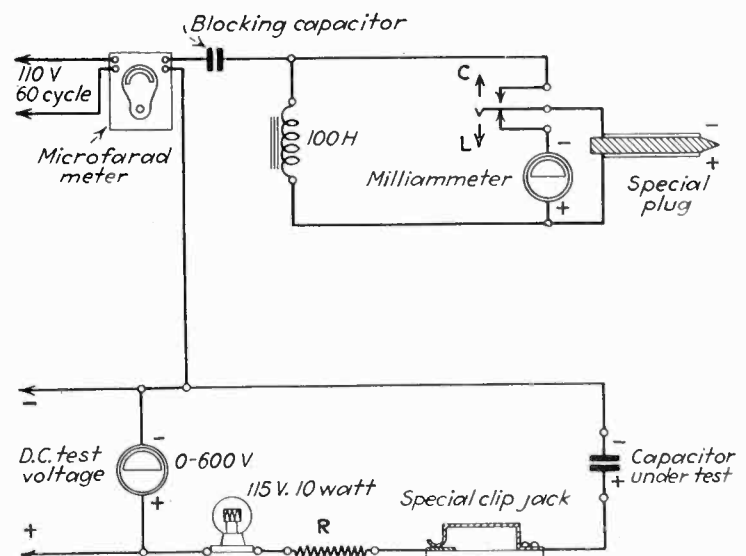

Fig. 4.—The use of a microfarad meter. The 10 watt lamp lights if high leakage or a short is present

RADIO ON BOARD THE NORMANDIE

Most elaborate marine radio system afloat installed on new liner



Members of the FCC inspect the radio room. Left to right: Commissioner Irving Stewart, Chief Engineer Jolliffe of the FCC, Chief Operator Jean Kerisit of the Normandie, Commander E. M. Webster, Asst. Ch. Engineer of the Commission, and Charles J. Panniell, Executive V. P. of the Radiomarine Corporation

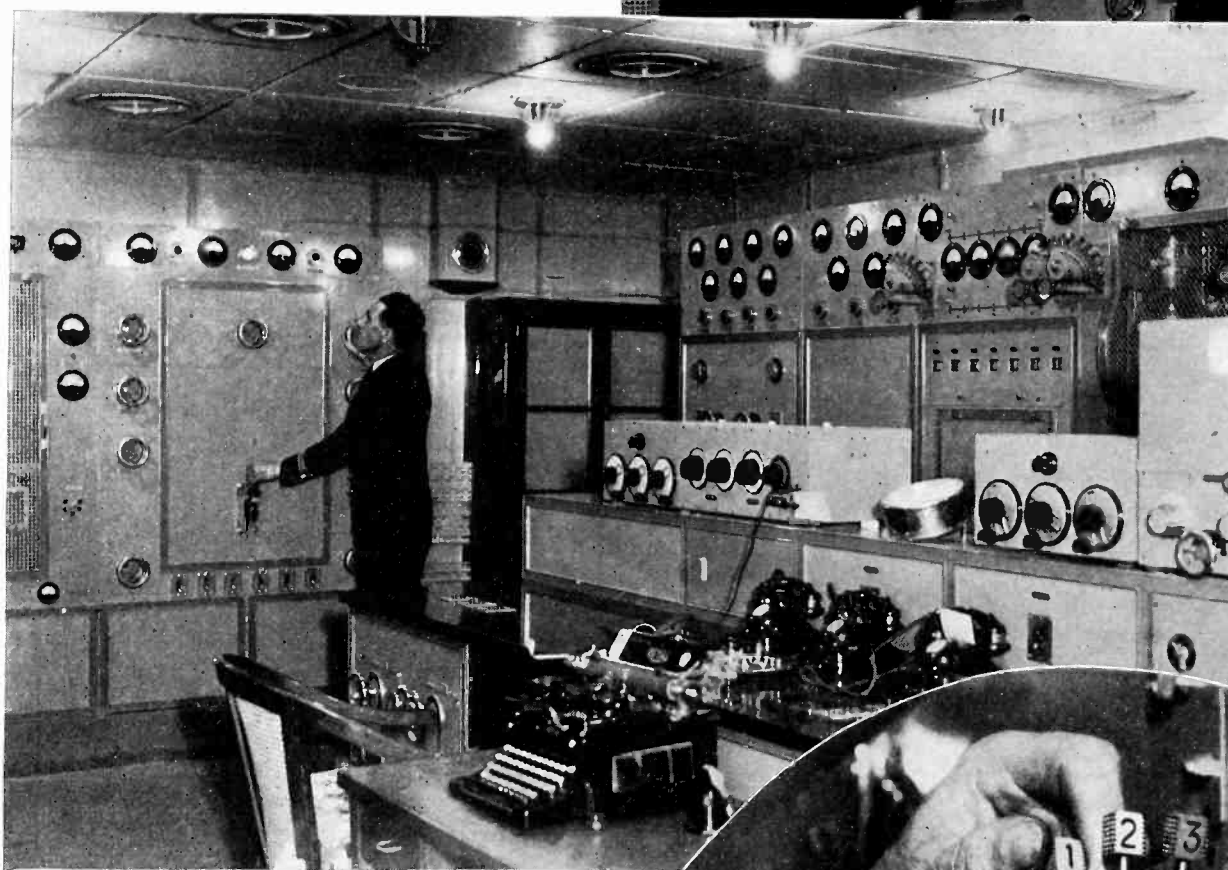

General view of the radio control room of the S. S. Normandie, showing Chief Operator Kerisit at the 2 kw transmitter. In the background to the right are two additional transmitters; in the foreground are receiving units and the central control desk. Six operators work simultaneously to handle the heavy traffic, while 80 loudspeakers, scattered throughout the ship, can be used for paging, concerts, and announcements. Two-way communication between France, the ship, and America is maintained at all times

Unusual tuning controls are used to maintain exact carrier frequencies. The numbers on each knob correspond to a definite frequency; in tuning, the operator turns the knob to the right, so that the knob-shaft springs down and engages a corresponding hole in the tuning shaft

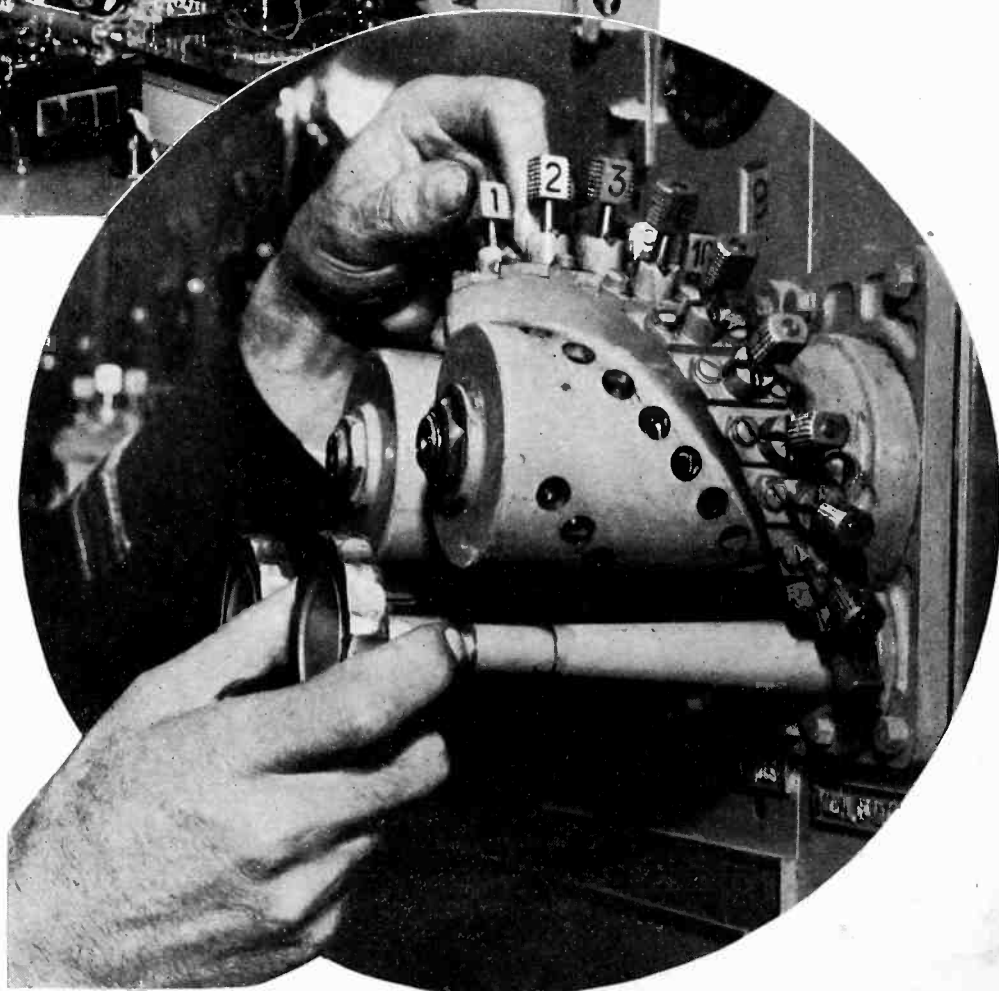

Adjusting the class B linear power amplifier

—in broadcast station equipment

By L. B. HALLMAN

Chief engineer, WSFA
Montgomery, Alabama.

THE adjustment of a class B linear power amplifier in a broadcast station, as any station engineer will testify, is a critical problem, and one on which both the efficiency and the fidelity of the entire station depend. It is true, however, that the adjustment can be approached from the standpoint of theory with results much more satisfactory than if cut-and-try methods are used.

By adjustment of the L/C ratio in the tank circuit of the power amplifier, the efficiency of the amplifier can be regulated over a wide range. If the efficiency is made too high, serious distortion will result, if too low, uneconomical operation and the possibility of overloaded power supplies result. In between these two extremes the proper optimum adjustment can be found as follows:

Determine the peak voltage across the load circuit. This is usually not higher than 0.8 of the battery or generator voltage applied to the amplifier. If higher values occur, then distortion is usually present. It is safe to assume that the peak voltage E_p is equal to 0.8 of the generator plate voltage. Secondly the peak power P_p should be determined. This is four times the rated power output of the amplifier, since at 100 per cent modulation, the power is four times the unmodulated power. Knowing the peak voltage and the peak power, the load resistance into which the amplifier must work can be calculated by

$$\frac{(E_p)^2}{2P_p} = R_L \quad (1)$$

where R_L is the load resistance.

The circuit into which the amplifier works is actually an L, C and R circuit as shown in Fig. (a). At resonance, as shown in Fig. (b), the LC circuit displays only a resistive component, i.e., the load resistance displayed by the circuit, equal to $R_L = L/Cr_1$, where L is the inductance of the tank circuit, C the capacity of the condenser and r_1 is the effective resistance. The resistance r_1 is made up of two parts, the residual resistance of the tank circuit inductance which can be measured directly, and the re-

sistance R_r which is reflected from the antenna to which the tank circuit is coupled. There are two formulas for determining this reflected resistance, depending upon whether the antenna is coupled capacitively or inductively. When inductive coupling is used, R_r is:

$$R_r = (2\pi fM)^2 / R_2 \quad (2)$$

where f is the radio frequency of the oscillations in the circuit, M the mutual inductance and R_2 the measured resistance of the antenna or transmission line. For capacitive coupling, R_r is:

$$R_r = (X_o^2 R_2) / (R_2^2 + X_o^2) \quad (3)$$

where X_o is the reactance of the coupling condenser at the operating frequency. Thus from measured values of the transmission line or antenna resistance and the mutual inductance or coupling condenser, R_r can be found.

The sum R_r and the residual tank-inductance-coil resistance is the total effective resistance r_1 . Knowing r_1 we can then rewrite equation (1) as:

$$L/C = r_1(E_p)^2 / (2P_p) \quad (4)$$

We thus directly evaluate the L/C ratio which will give the optimum operating condition for the amplifier.

To find the absolute values of L and C we have only to consider that the product LC is a constant for any given frequency when the circuit is tuned to resonance. Thus:

$$LC = 1/4\pi^2 f^2 \quad (5)$$

where f is the frequency in cycles per second, L the inductance in henries, and C the capacity in farads.

Using (4) and (5) as simultaneous equations, we can solve at once for L or C depending upon which is easiest to adjust. If C is solved for, C is fixed at that value and L is then adjusted to bring the transmitter into resonance.

A practical example will be quoted to illustrate the method: A 1000 watt transmitter 100 per cent modulated has a peak power of 4000 watts. The generator voltage is 4000 volts. The peak voltage is then $0.8(4000)$ or 3200 volts. Thus $P_p = 4000$ and $E_p = 3200$. The effective resistance r_1 is made up of the residual tank inductance resistance, which is measured to be 1.5 ohms for this particular transmitter, and the reflected resistance

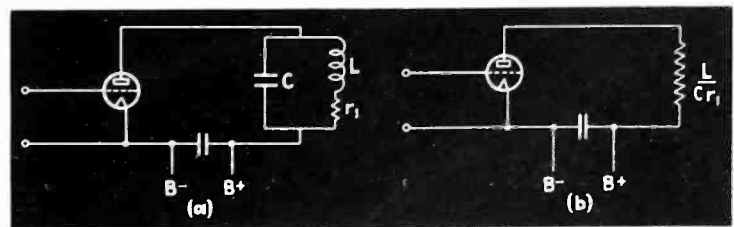

The actual and equivalent tank circuits which load the linear amplifier

R_r . R_r is reflected from a 20 ohm antenna capacitively coupled through a $0.01 \mu f$. coupling condenser. The frequency f is 1000 kc. Using equation (3) R_r is found to be 7.75 ohms. The sum of this and the 1.5 ohm residual resistance is 9.25 ohms, the effective resistance r_1 . Substituting these values of E_p , P_p and r_1 in equation (4) gives an L/C ratio of 11,800. The LC product at 1000 kc. is 2.53×10^{-14} . It follows then that $C^2 = 2.14 \times 10^{-18}$, and $C = 0.00146 \mu f$. In this transmitter a $0.0015 \mu f$ condenser is actually used. The plate circuit efficiency is around 30 per cent, for the unmodulated carrier.

In some cases it may be found that the above procedure does not give the optimum position at once, but in every case the adjustment so made is near the optimum, and a further cut-and-try adjustment will bring the amplifier to the correct operating point.

HIGH LIGHTS ON ELECTRONIC

Savings with photo-electric color-control in bakery

BY TAKING advantage of the sensitivity of the photoelectric cell to color changes, the Cubbison Cracker Co., Inc., Los Angeles, Cal., has put under precision control a process which formerly produced much waste and a non-uniform product. Before the electric eye was put into service, the oven for toasting swieback, melba toast, etc., was manually controlled, and it was necessary to retoast daily about 8,000 slices which came through too light in color, and to destroy from 2,000 to 3,000 pieces that were burned. All of this has been eliminated by photocell regulation.

Two photocells are used, these being spaced about 2½ ft. and 7½ ft., respectively, from the end of the last section of the oven. Toast passing the first eye is brought to that color which it ought to have at the time it enters the space between the two photocells. Should the pieces be too dark, this first cell turns off a pair of heater elements (one top and one bottom) just ahead of it. This assures that the next toast passing it

will be of the proper tone and puts it up to the second eye to perfect the coloring of that which goes by the first eye "off-color." When the toast reaches the second photocell at the peak color, that cell turns off the heat from there on. But if it is too light in color, the eye turns on, or leaves on, the last two heaters.

Before the photoelectric color control was installed at the Cubbison Cracker Co., it was the work of the operator to watch the toast as it emerged from the oven and turn off or on one or more of the heater elements in the toasting section when the color was not right. Since the operator could not be sure whether the toast was off color until it had come out of the oven, his judgment and skill were constantly taxed to maintain the proper regulation.

Accuracy, economy, speed and reliability are attained. As to accuracy, the difference in color which actuates the relay can hardly be detected by the human eye. Furthermore, the off color is detected at a time when correction can be effected. The cost of installing the control equipment is not high, amounting to only \$250 for a

single control circuit, or \$500 for this double unit used by Cubbison Cracker Co. This investment is returned many times in the form of savings in power and labor during a year of operation, to say nothing of the waste eliminated and the uniform product obtained. Occasional cleaning and changing of light bulbs to keep constant the amount of light thrown upon the toast is required. No periodical calibration is necessary.

The power consumption of the two light sources is more than offset by the promptness of the system in turning off the heater current.

To protect the light source and photocell against the high temperature in the oven, the ports through which the light shines upon the toast and through which the reflected light passes to the photocell are heat-insulated. These ports are concentric horn-fiber tubes separated by dead air spaces. The center, or light-transmitting tube, has in the end next to the oven a window comprising three pieces of glass with dead air spaces between. Although the temperature in the oven reaches 350 deg., that at the photocell is only 80 deg. Both the light source and the photocell are readily removed.

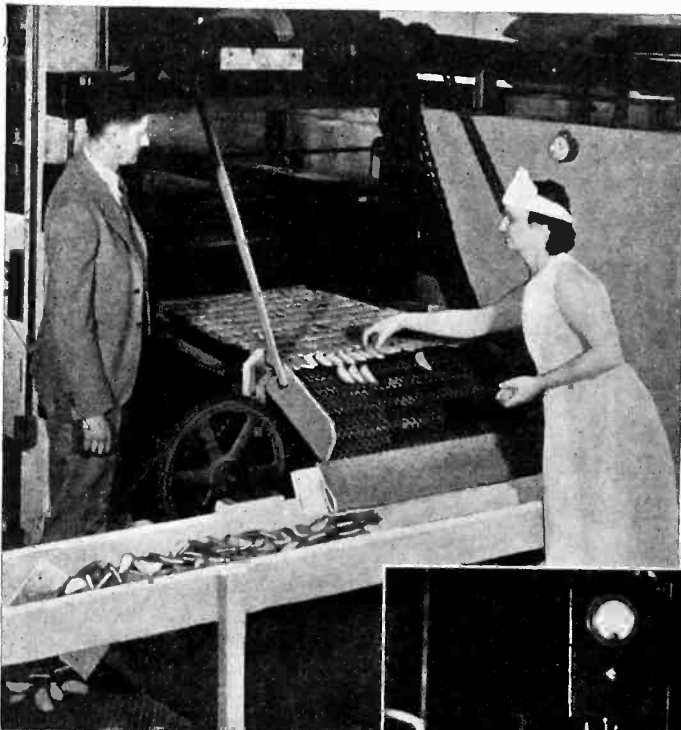

Left — Bread slices leaving oven after toasting to the correct color under heat regulated by photocells

Right—Adjusting the photoelectric control to the degree of brownness desired

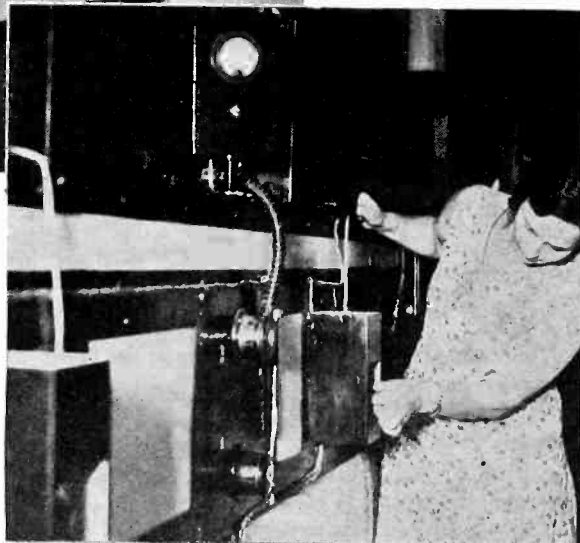

Watch ticks analyzed to locate errors

A WATCH-ANALYZING mechanism which checks timepieces and automatically prints a case-history picture of any trouble, has been perfected by Charles J. Young and Maurice Artzt, RCA-Victor research engineers from Camden, New Jersey.

Development of this "Chronograph" system makes use of the technique of facsimile or "still-picture" transmission by radio. With this device the time-keeping capabilities of a watch to an accuracy of within one second a day can be determined in a single minute, as compared to many hours required with methods now in use. Moreover, the apparatus supplies a "written" picture record of any irregularities which may impair the satisfactory operation of the timepiece. The system makes use of a tuning fork, accurately temperature controlled, as a time-frequency standard. This controls the speed of the driving motor, which in turn actuates the facsimile recorder. The recorder mechanism is identical to a simplified facsimile printer used for the reception of radio pictures and written matter,

DEVICES IN INDUSTRY + +

and employs ordinary carbon paper to print on ordinary paper. The watch to be checked is placed on a special micro-

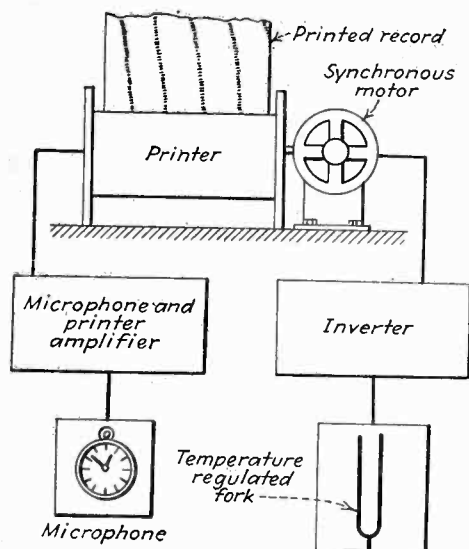

Watch-tick analyzer

phone case which picks up the ticks and carries them to an amplifier system. The amplified ticks are then made to actuate the printer recorder mechanism. If, as the paper moves along, the marks produced by the ticks waver, or deviate from a predetermined straight line, the watch is shown to be either fast or slow, depending on the extent of the deviations, and the number of seconds it is in error may be computed at once.

According to the inventors, an error of one part in a million may be recorded and measured in about eight minutes of testing, which error would show as a deviation of $\frac{1}{2}$ of an inch in slightly over 16 inches of record. Irregularities in the action of the watch are interpreted in terms of corresponding irregularities on the printed record.

When smelter bag tears, phototube sounds horn

A PHOTO-ELECTRIC tube is employed at a zinc smelter in Mexico to record and notify operators when a bag in the bag house bursts, with the consequent loss of valuable metal particles up the flue. Inasmuch as the phototube gives instant warning of such failure the apparatus has more than paid for itself.

The bag house is built in sections each containing approximately 72 bags. The sections are independent except that they receive the gases from the roasters through a common header, and after passing through the bags the gases are discharged into a common stack. Each section has a large air-operated,

manually-operated mushroom valve near the bottom of one side for shutting off the gas when the section is taken out of service.

The protective device depends on a ray of light passed through the flue gases. The opacity of the latter is measured by the amount of this light received by the phototube on the far side of the stack. The current delivered by the phototube operates a recording meter in the office. When a bag tears, the resulting dust reduces the light intensity so that the meter reads approximately half scale. Preadjusted contacts cause a Klaxon horn alarm to sound.

Prevents elongation of pattern

IN THE automatic stamping of steel strip, elongation of pattern is often troublesome, particularly if the machine applies too much tension.

The difficulty has been solved by a photo-cell, in connection with an illuminated "negative gage" in the machine, which matches the punched-out section. If light shows through, a photo-cell operates an alarm. The draw can then be re-adjusted, and scrappage is maintained at a minimum.

Advance notice of flood's approach given by automatic radio

IN FLOOD-CONTROL work in the mountains of the West, it often becomes important to know, in advance, about the rise of flood levels in mountain streams far from human settlements. If the engineers on duty below can learn that streams have risen to dangerous levels on the upper catch-basins, they are able to prepare for handling the flood when it reaches the valleys where serious damage may be done.

Irvon M. Ingerson, associate hydraulic engineer for the California Department of Water Resources, has developed an automatic radio gauge which can be used in forest lands and mountain wildernesses where no telephone wires are available.

The alarm mechanism is connected with a float which rides up and down inside the metal pipe, with the water level in the stream. At intervals the radio transmitter sends out signals indicating the level at which the float is standing, so that the stream-control men on watch have advance warnings of the approach of flood crests.

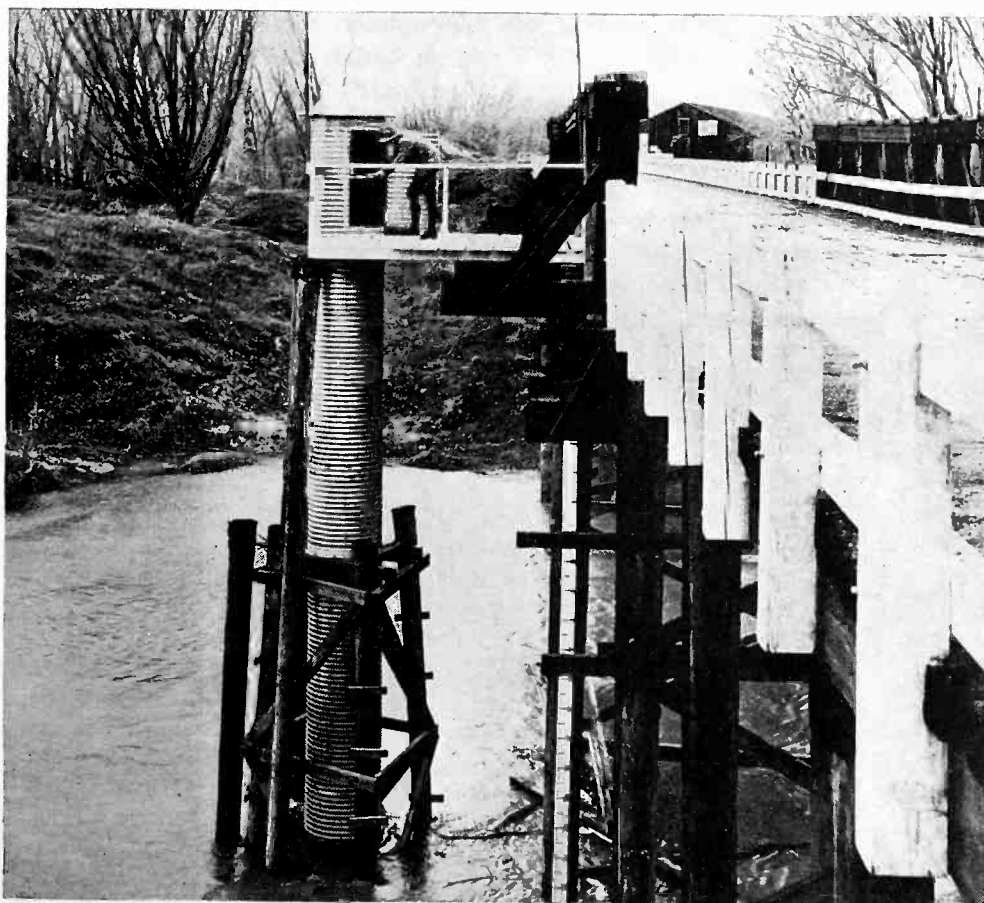

Flood control has been materially aided by the use of automatic radio transmitters which warn headquarters when waters rise to the danger level. The equipment, which is semi-portable, can be moved to locations of greatest importance during the flood season

Measured input losses of vacuum tubes

By C. J. Franks

Boonton Radio Corporation
Boonton, New Jersey

IT IS generally assumed that the input circuit of a vacuum tube, looking into the grid-cathode terminals, is essentially a small, almost loss-free capacitance, provided that the load impedance connected in the plate circuit is such as not to reflect resistance into the grid circuit. This is a condition approximately fulfilled in any detector application where the plate is bypassed to the cathode, and covers all of the cases considered herein.

That there is a loss in the dielectrics used in the tube would scarcely be denied by anyone, yet the common conception of the magnitude of this effect is such that the input loss of a vacuum tube voltmeter is ordinarily considered equivalent to the shunting effect of the grid leak resistor only, whence arises the assumption that a tube voltmeter may be connected across any circuit at any frequency and its effect on the losses of the circuit neglected. The facts are at considerable variance with this assumption. In one carefully designed and built tube voltmeter, the effect of the ten-megohm gridleak was rather small compared with the losses introduced by the tube, the terminals, and the dielectric loss in the series grid condenser; the effective shunt input resistance of the instrument was measured and found to be 2.8 megohms at 1000 kc., dropping to 0.3 megohm at 10 mc.

The problem was next encountered in a manner which emphasized even more strongly the danger of taking tube losses too much for granted. Alarming losses were found in an application in which a tube voltmeter without terminals or series condenser, and with a 100 megohm leak as the only external source of loss was connected across a tuned circuit. The shunt loss resistance of the voltmeter was measured and found to be less than two megohms at 1000 kc., a value changed only a minute amount by the removal of the 100 megohm leak. Several samples of the same type of tube, the 2A6, were measured, and while some variation was found, the values obtained clustered fairly well around an average of three megohms at 1000 kc. A plot of effective shunt resistance of the input circuit of a typical 2A6 against frequency is shown in *A* in the figure.

It will be seen that at frequencies above 5 mc. the input

loss with the tube heated and normal (rectification) voltages applied is greater than for a cold tube. This is due to the fact that at these frequencies the time required for an electron to pass from cathode to plate becomes comparable with the time of a cycle of the input voltage wave. During the time that an electron is under the influence of the grid potential, an appreciable variation of the instantaneous grid potential occurs and work is done on the electron. Work done is energy dissipated; the energy must come from the input voltage wave, and the effect on the external circuit is the same as though a resistance having the correct value to absorb the same amount of power had been connected between grid and cathode, adding to the loss already occurring in the tube's dielectrics. It is the total effective value of this shunt loss resistance which is shown in the figures.

Causes of input losses

Barring a complete redesign of the tube, little can be done about the electron losses. However, at the lower frequencies in this particular tube, the electron losses are small compared to the fixed or dielectric losses measured with the tube cold. A tube was dissected and the loss contributions of the various parts measured, and it was found that almost all of the loss was in the mica pieces used to maintain proper spacing of the electrodes. A search resulted in the finding of some tubes having specially treated micas, and measurement of these tubes showed that their losses were extremely low, input shunt resistance values of the order of ten times those previously measured being obtained. Using these low-loss tubes as voltmeters, it was found possible to design an instrument

for the direct measurement of $Q \left(\frac{\omega L}{r} \right)$. In this instru-

ment the Q of the circuit is indicated in terms of the voltage developed across the circuit, this voltage being measured by a vacuum tube voltmeter having its scale calibrated directly in Q . Using the tube with untreated micas increased the losses sufficiently to cause errors of reading of from ten to twenty per cent, while with the low-loss tubes in the voltmeter the drop in Q due to the loss in the voltmeter was less than $\frac{1}{2}$ of one per cent for circuits having Q 's of the order of 200.

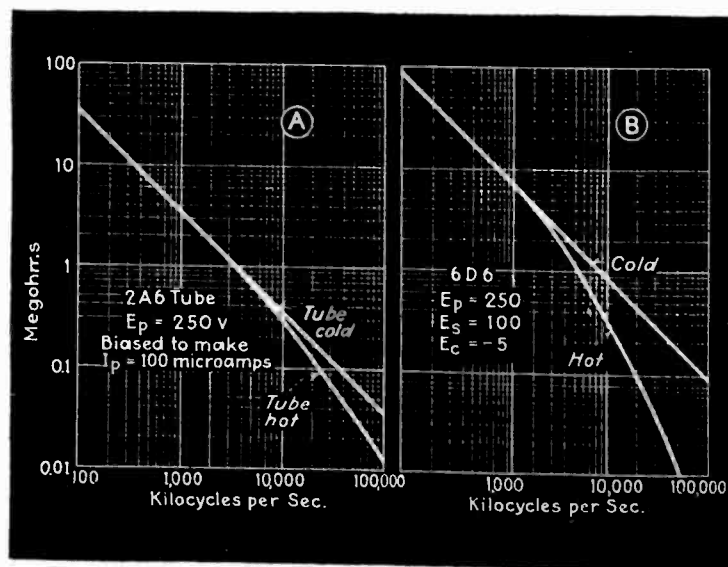

Effective shunt resistance as a function of frequency of (A), a 2A6 and (B) a 6D6, measured by the methods outlined in the article

At the completion of the investigation of the vacuum tube voltmeter, the question of the input losses of an amplifier tube was raised, and a further series of measurements made to determine the answer to this. A 6D6 tube measured in the same manner gave the results shown in Fig. 2. The plate was bypassed to ground, and the electrode voltages with the single exception of the bias were normal for amplifier service. The bias was increased to five volts in order that the approximately 3 volt testing signal voltage would not overshoot the bias and give abnormally low values of input resistance. A check proved that this slight increase of bias had an inappreciable effect on the effective resistance.

The electron stream loss is greater in the 6D6 than in the 2A6, and begins to be apparent at a lower frequency. This is probably due to the greater electrode spacing of the 6D6 and to the lower effective accelerating voltage. In the triode the full 250 volt plate potential is effective in accelerating the electrons toward the plate, while in the shielded tube only the 100 volt screen potential is active in pulling the electrons through the grid, with the result that they travel more slowly, stay within the influence of the grid over a greater portion of the cycle, and so absorb more power. Theoretically, an increase of bias voltage would decrease the loss by lessening the electron density near the grid, but a check of this on the 6D6 showed an effect small in comparison with the difference due to the other two effects.

An explanation of the method used in obtaining the data given may be of interest. The substitution method was proposed but was abandoned because measurement of various representative composition resistor units showed that the actual values of such units departed widely from the nominal or d-c values as the frequency was increased. It was therefore decided to measure the tube losses in exactly the same manner in which the checks

VACUUM TUBE INPUT LOSSES

TAKING input tube losses for granted can lead to serious errors when critical measurements are performed. Complete loss-frequency measurements on two typical tubes are presented here. Poor-quality mica supports contribute greatly to the observed losses.

of the resistors had been made, that is, by noting the effect which the unknown produced when connected across a tuned circuit.

A suitable coil is set up in the Q -Meter and resonated to the desired test frequency. The tuning capacitance, which must be the true total capacitance including the coil's distributed, is noted and called C_o , while the circuit Q is called Q_o . Then the unknown is connected across the circuit and the resultant C_r and Q_r noted. The effective capacitance of the unknown is of course the difference between C_o and C_r , while the effective shunt resistance in megohms of the unknown is

$$R_x = \frac{1.59 \times 10^2}{FC_o} \times \frac{Q_o Q_r}{Q_o - Q_r},$$

C_o and F being in micro-microfarads and kilocycles per second, respectively.

A study of the sort described emphasizes the danger of taking circuit components too much on faith. Even our modern tubes cannot be used in any critical measuring applications until they themselves have been carefully measured and their possible contributions to the errors determined.

Engine indicators

[Continued from page 213]

a break in the impulse at its peak value. A variable condenser whose plates are of the proper shape may be employed as indicated before. The use of small alternating and sinusoidal voltage generators requires special voltage regulation, as constant amplitude is absolutely imperative.

Multi-cylinder measurements

In the observation of multi-cylinder engines it is obvious that a switching arrangement is necessary for the chronological observation of each cylinder. Furthermore, a phase change device is needed for the time or volume axis. As previously mentioned, for slow or idling speeds, anode voltage interruption for screen fluorescence persistence is also required.

REFERENCES

1. "Engine Indicator — its design and theory" — K. J. DeJuhasz.
2. "An Electric Engine Indicator"—E. J. Martin, *Electric Journal*, Feb. and March, 1930.
3. "Piezo-electric Pressure Indicator"—Watson and Keys, *Canadian Journal of Research*, March, 1932.
4. "Piezo-electric Pressure Indicator"—Forschung auf dem Gebiete des Ingenieurwesens, May-June, July-August, 1933.
5. "Piezo-electric Pressure Indicator"—*Genie Civil*, July 2, 1932.

6. "High Speed Engine Pressure Indicators"—Air Corps Information Circular, Vol. 7, No. 681, May 15, 1933.

7. "A New Electrical Telemeter"—B. McCollum and O. S. Peters, Tech. Paper Bureau of Standards, No. 247.

8. "Bulletin No. 73 on McCollum-Peters electric telemeters"—May, 1934. Baldwin-Southwark Corporation.

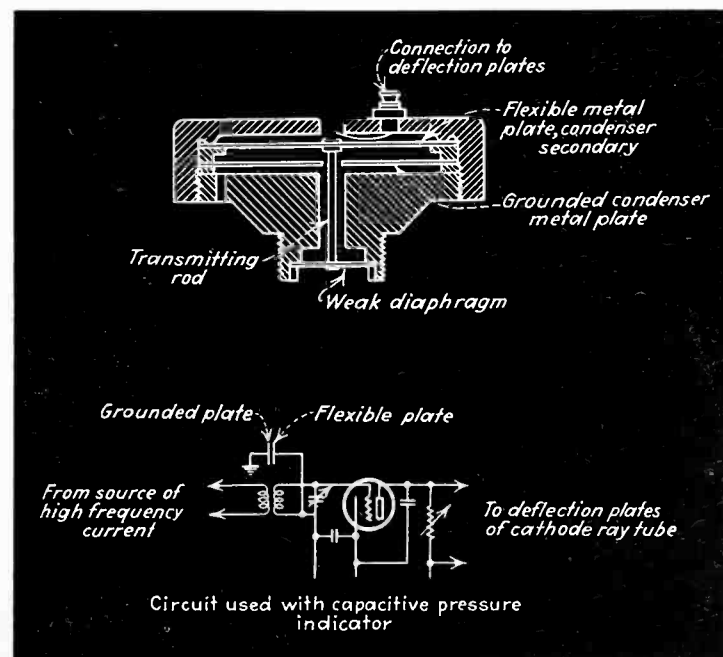

Fig. 4—Condenser type pressure indicator. The circuit used for coupling to the cathode-ray tube is shown below

+ + NOTES ON ELECTRON

A high-speed direct-reading frequency meter

A DIRECT-READING electronic frequency meter has been developed by Frederick V. Hunt of the Cruft Laboratory, Harvard University, as first reported in the *Review of Scientific Instruments*. As shown in the circuit diagram tubes A and B are grid-control rectifiers connected in an inverter circuit, whose frequency is controlled by the signal applied across the input terminals. When tube B is non-conducting the condensers C and C_m associated with tube A are charged to the voltage existing across resistor R, while the condenser C_m associated with tube B remains uncharged. When in response to the signal at the input terminals the grid of tube B is made sufficiently positive to make tube B conduct, the potential of the cathode of tube B rises abruptly.

Since the charge across condenser C is not dissipated immediately the cathode of tube A is charged positive with respect to its anode and as a result tube A is extinguished. At the same time both anodes of the double-diode D become positive because of the charge on condensers C_m and as a result a positive current is delivered to the microammeter in series with the cathode of the double-diode. The average current delivered

to the indicating instrument or microammeter is directly proportional to the number of pulses delivered to it per second, therefore the indication of the instrument is proportion to the frequency of the input signal. This proportionality can be extended over wide limits within the audible range, the upper limit depending upon the capacities C and C_m . The essential limitation

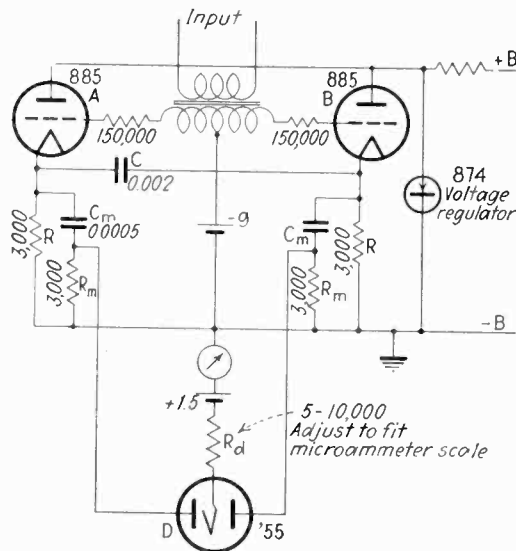

Frequency meter diagram

is the ionization time of the thyratrons. From 0 to 7,000 cycles per second in a typical example in which the linearity of the instrument with frequency is greater than $\frac{1}{2}$ of 1 per cent.

Many uses have been suggested for the frequency meter particularly in the field of recording, for identifying frequencies of vibration in rotating machinery or in noise studies. It has also been suggested that the instrument would be valuable in the teaching of singing or in the playing of musical instruments. Deaf and dumb people might also use the instrument to gage the frequency at which they are speaking, so that they may speak with normal intonation.

A photocell temperature regulator

By C. E. WEINLAND
Physicist, Johns Manville Research Laboratories.

THE USE of the photocell in controlling temperature is by no means new. The novelty in the circuit to be described lies in the logical combination of inexpensive items of standard equipment into a controller which will give results that compare very favorably with the work of expensive commercial instruments.

Referring to the schematic circuit in the figure the temperature of the furnace A is to be controlled in accordance with the E.M.F. indication of the thermocouple B. The contact on the slidewire C is first set to the potential which the thermocouple will develop when the furnace is at the desired temperature, by throwing the switch to position D, when the potential can be read on the potentiometer F. By throwing the switch to the operating position E, the thermocouple is connected through the L & N Type P No. 2239-C wall type galvanometer G, in opposition to the slidewire potential, so that when the two potentials are equal no current will flow through the galvanometer and it will not deflect. Then any change in thermocouple potential will result in a galvanometer swing one way or the other.

The filament of a 6 volt 21 c.p. automobile lamp H is imaged by a lens upon the mirror of the galvanometer, where another lens I images the slit J upon either of the photocells K (Type 868) by reflection in one of the two mirrors L. The photocell current is amplified by the corresponding '71 tube M, and operates the sensitive Struthers Dunn CSB-51 relay N, which in turn operates the corresponding coil of the mechanical latch electrical reset relay A, (Struthers Dunn CS600C) which controls the power relay P. Current for the 5 volt tube filaments and the lamp is supplied by the low voltage trans-

"VOICE-READING" WITH NEW FREQUENCY METER

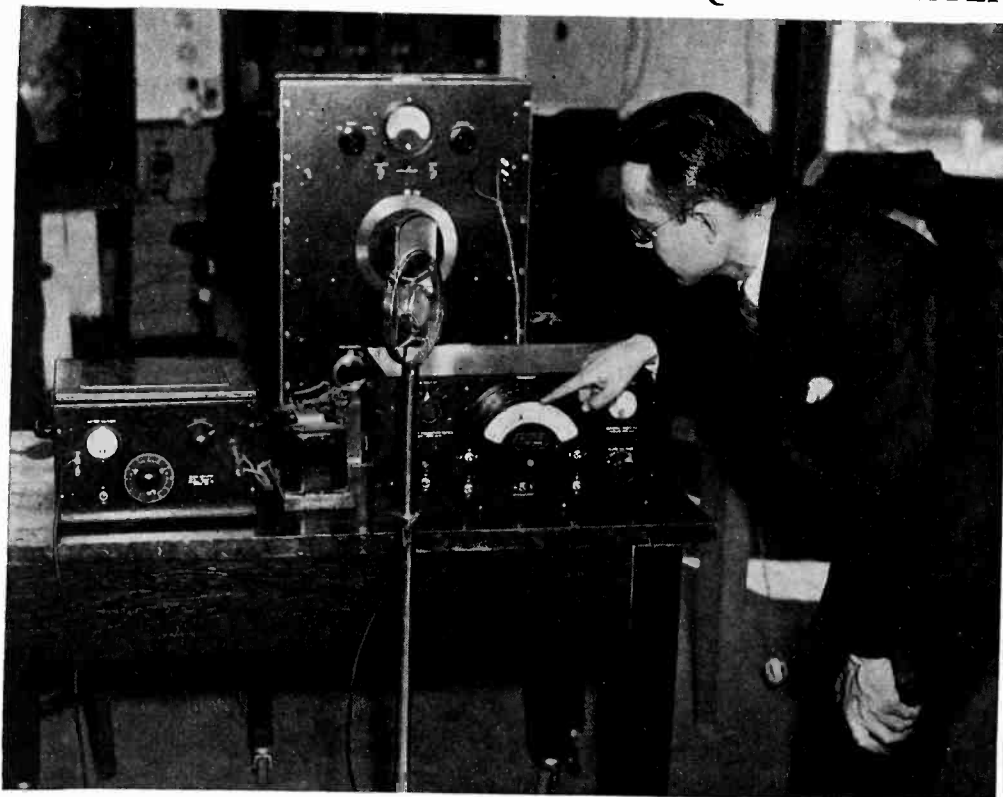

F. V. Hunt of Harvard with his direct-reading high-speed frequency meter. Deaf people are enabled to "read" the pitch of their voices with this device

TUBES AND CIRCUITS + +

former Q, while grid and photocell anode potentials are secured from the variable 5000 ohm voltage divider R. All power to operate the regulator circuit is supplied by the transformer S, through the switch T, while furnace heating power may be shut off by opening the line switch U.

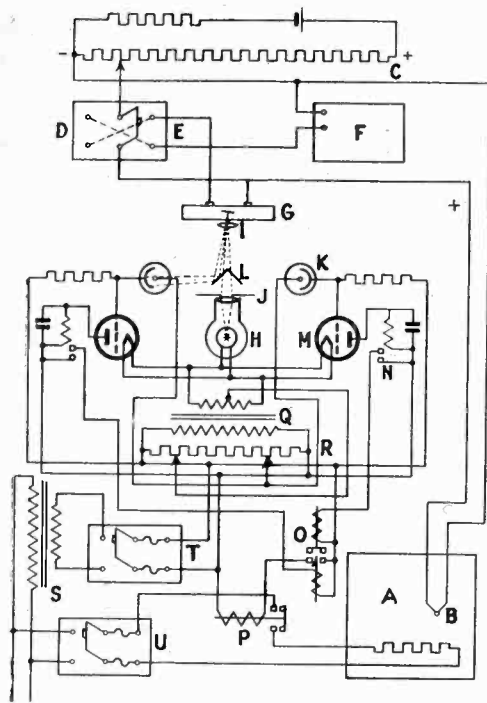

Temperature control circuit

In putting the controller into operation, the thermocouple circuit switch is first thrown to position D, when the galvanometer is shorted through this switch and may be adjusted for zero so that the reflected light beam falls on the apex of the mirror angle, while at the same time the potentiometer F will be connected to read the potential setting on the slidewire C, which should be adjusted to the value corresponding to the desired furnace temperature. When the switch is then thrown to position E the galvanometer will deflect and through the actuated photocell and relays turn on the furnace power, which will then remain on even though the galvanometer beam swings on past the photocell, and in fact until the beam has return past center and has actuated the photocell on the other side, causing it to trip the mechanical latch relay and break the power circuit.

If a low resistance slidewire C is used, a protective resistance may be required in series with the galvanometer. On the other hand, with a high resistance slidewire the protective resistance may be omitted, with a resulting gain in sensitivity. Ill effects from overdamping the galvanometer need not generally be feared.

In an on-off control circuit of this type, one must usually choose between a

thermocouple location close to the furnace charge or one close to the heating element. The former will result in close control of average temperatures but with wide swings between maximum and minimum due to the temperature-time lag between heating elements and thermocouple, while in the latter case a thermocouple location in intimate contact with the heating element itself will greatly reduce temperature oscillations, but at the same time will introduce variations in mean temperature of the charge that may or may not be systematic. In cases where a large proportion of the required power can be supplied continuously to the furnace, with the controller handling only a small variable portion, much better temperature control can be obtained. In many cases, and the higher the furnace temperature the more likely the case, care must be exercised to ground the thermocouple, or to shield it electrically from the heating element, or erratic operation may result.

A controller utilizing this circuit has been in use for some time, operating a 440 volt, 18 K.W. Globar furnace at various temperatures up to 2500° F. Considering the controller alone, the thermocouple potentials corresponding to the "on" and "off" operating points may easily be made less than 0.1 mv.

Notes—

1B5/25S tube—tube manufacturers announce a 2-volt filament type of tube capable of performing simultaneously the functions of detection, amplification and AVC. It has two diodes and a triode, one diode being at each end of the filament.

Short-wave radio for Stock Exchange—radio sets with a range of only 10 feet have been developed for quotation boys on the New York Stock Exchange to transmit quotations to the top of the posts where the signals are amplified for relaying to the 15th floor of the building for retransmission to the various member firms.

2A7-6A7 troubles—variations as much as 5 to 1 have been found in the characteristics of the pentagrid converters considering the products of several manufacturers, and of 2 to 1 among tubes of a given manufacturer. Now Triad engineers have prepared a report on these variations and on the general subject of pentagrid converter troubles. It is available for engineers desiring it. *New metal tubes*—RCA Radiotron announces the 6F6 a power amplifier pentode with characteristics similar to the 42 and the 5Z4 which is a full-wave high vacuum rectifier, having a double metal shell.

ROTATING SPEAKER PRODUCES UNIFORM FIELD

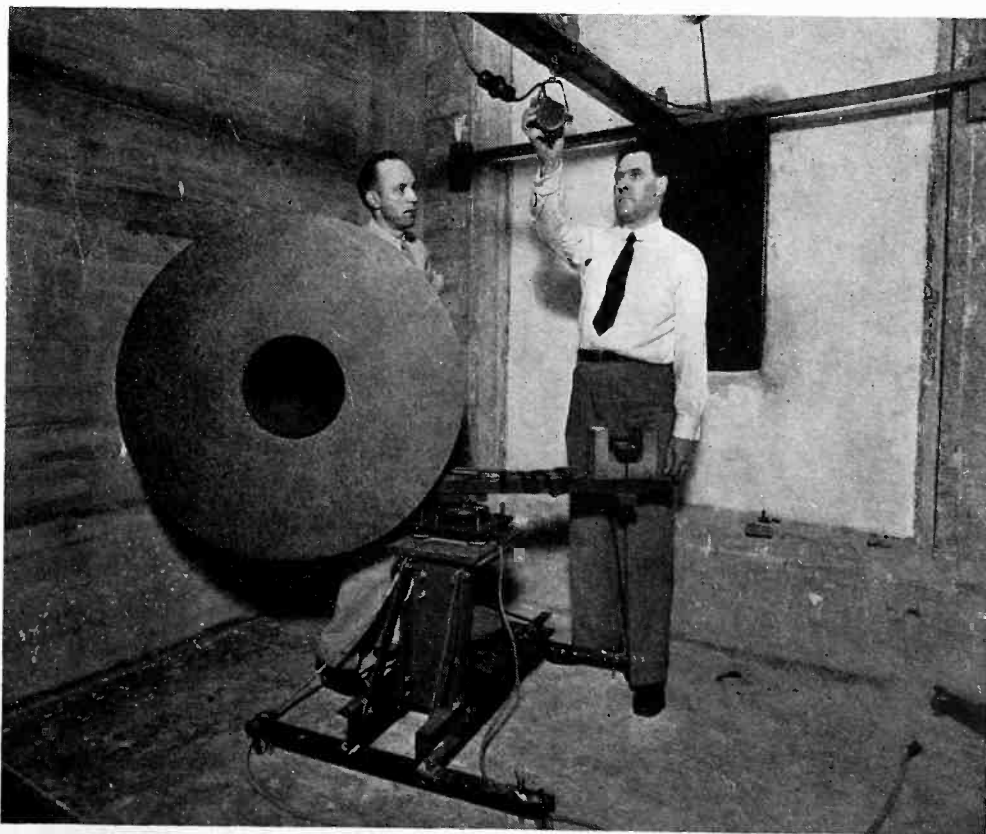

W. F. Snider and V. L. Chrisler of the U. S. Bureau of Standards with the rotating loudspeaker used in testing insulation materials. The movement of the speaker prevents standing-wave patterns

electronics

McGraw-Hill Publishing Company, Inc.
330 West 42d Street
New York City

ORESTES H. CALDWELL, *Editor*

KEITH HENNEY, *Managing Editor*
DONALD FINK

Vol. VIII

—JULY 1935—

Number 7

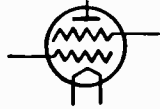

Cheap parts—and later service costs

CHEAP parts and materials entering into radio-set production, constitute a self-evident evil. But do radio manufacturers ever stop to think how much service expense and trouble is imposed on the customer, by reason of price-chiseling at the point of manufacturer's purchase?

Here is an argument which the legitimate and meritorious parts manufacturer can use on his set-maker customers.

Radio-set users want, above all else, *dependability*. Inquiries among lay listeners show that whatever their interest in tone quality, sensitivity or other refinements, they put above everything the matter of continuity of operation and freedom from service calls. Any failure of the set is a "100-per-cent failure," however simple and trivial its cause. Such failures too often result from poor-quality materials or cheapened parts. The final customer eventually pays the penalty for inter-industry price-gouging, and takes it out of the manufacturer's good will!



The shifting picture of radio reception

SURVEYS of radio broadcast conditions now being made in large numbers, frequently have the fault of implying that the findings may be expected to remain *fixed* and *constant* for the

future. On the contrary, clients should be told that the service areas of broadcast stations are not definite and unchanging, but can be expected to vary widely from year to year, with changes in cosmic conditions. A few years ago, the average fading ring of clear-channel stations was 100 to 150 miles from the transmitter. But this winter and last, the area of distortion and fading crept up to within 30 to 60 miles of the same station towers, attributable to a minimum of sun-spots and solar disturbances.

The short waves for trans-oceanic communication have been undergoing a similar striking change of performance. Back in 1928, at the time of the sunspot maximum, 16-meter waves were suitable for talking across the Atlantic. With the wane of solar activity in the following years, the wave-length necessary to get the same results increased to 20 and 30 meters, and there were even short periods during the past season when 42-meter waves were required to duplicate the former performance of 20-meter waves.

Radio reception is a shifting picture, and radio men must recognize this if they are to interpret correctly findings made a few months or a few years before.



The Faraday Medal to Dr. Jewett

THE highest honor of British electrical science was paid to Dr. Frank B. Jewett, president of the Bell Telephone Laboratories, when the Institution of Electrical Engineers of London this year conferred upon him the famous Faraday Medal "for notable scientific achievement in electrical engineering, and conspicuous services rendered to the advancement of electrical science."

Dr. Jewett is the first American-born engineer to receive the award, and his own brilliant career, culminating in a vice-presidency of the American Telephone and Telegraph Company, epitomizes the utilization of science by big business, to promote the service of electricity to the public. Coming from the Chicago University group also made famous by Michelson and Millikan, Dr. Jewett undertook the problem of making the then fitful electronic amplifier or "repeater" work as a dependable tool of telephony. Trans-continental speech shortly followed, and then came commercial telephone service to England, Europe, Africa,

and now to Australia and Japan. Meanwhile notable advances in radio broadcasting, television, magnetic materials, and telephone practice have come from the vast laboratories and thousands of workers under Dr. Jewett's direction.

The great name of Faraday is appropriately linked with that of this friendly, hard-working, courteous gentleman who stands in the front rank of electronic research.



An orchestra in the living-room

THE new possibilities of "auditory perspective" might well be harnessed to open up new home markets for the electric phonograph. Suppose that the electric phonograph of the future were equipped with two loudspeakers marked "right" and "left," and each at the end of a 10- or 15-ft. cord! With some of the new developments of recording of two channels in either the same or adjacent grooves, appropriate pickups could be arranged to feed these two speakers. With the portable speakers ranged across the end of a living-room, new degrees of auditory reality would be achieved.

In the case of an orchestral selection, the fortunate listener would *hear the players seated across the end of his living-room*—the violins on one side, the brasses on the other, the drums in the rear, and even a soloist walking up and down across the end of the living-room. Two actors in a play might appropriately speak from different sides of the room. Amos and Andy could be heard each in his separate corner.

The electric phonograph industry is about due for some new sales appeal. A binaural (or would it be "bi-lingual"?) era in phonographs, achieving auditory perspective in this way, might offer the same kind of sales tonic as was accomplished by the sainted "ortho-phonic," back in its dim day of fractional fidelity!



Concealed all-wave antenna connections when the house is built

WHEN a modest home is equipped for the use of electricity, it is no longer the custom to run the wires around on the surface of the walls, as an "afterthought." Standards of elec-

trical housewiring now provide for concealed construction, which can be installed before the house is plastered and finished, making a workmanlike job, "out of sight."

Yet when a radio receiver is to be put into that same dwelling, the antenna and ground wires almost invariably are "slapped in" in the crudest manner. Exposed wires lie across wainscoting and walls; connections come in through windows or other unfit openings. Radio connections are chiefly makeshifts, even in 1935. And the situation gets worse with the new all-wave antennas, which should have expert installation, and which must be connected to the receiver correctly, preferably by out-of-sight wiring.

It is high time therefore that a standard practice for antenna lead-in construction be provided for architects and builders, along with their electrical wiring specifications, so that proper all-wave antennas can be installed and connected to the receiver by concealed wiring when the dwelling is built. Such specifications are badly needed, and radio men will have to show the way.

NBC'S NEW ECHO CHAMBERS

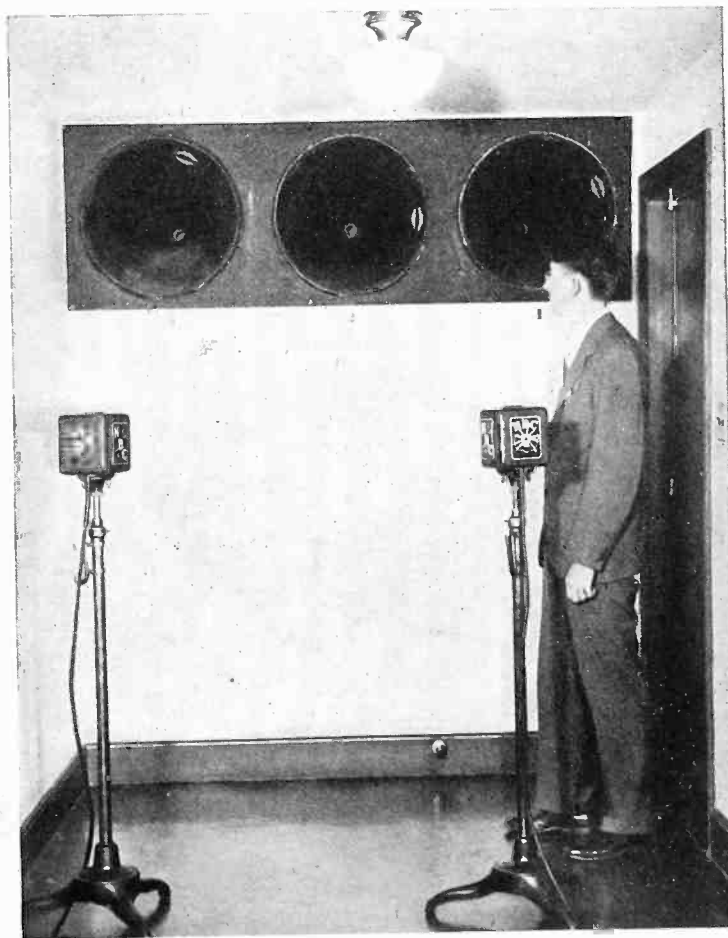

Robert M. Morris of NBC's development laboratory, and the new "echo chamber" at Radio City, — fed by three speakers through cement-lined pipes 20, 40 and 80 ft. long

A REVIEW OF THE ELECTRONIC ART

HERE AND ABROAD

Grid-to-top tubes on British market

ONE OF THE CHIEF differences between American and British r.f. tubes has been their consistent disagreement on the subject of grid or anode to top cap. America has standardized grid, and Britain—as well as Europe—has always taken anode to top and grid to base.

Now comes news of a new tube which may swing the balance to universal use of the American system. This is the r.f. pentode—double diode, which has been introduced in order to simplify the circuit layouts of a very popular British circuit.

One of the biggest sellers in Britain is the 3 tube set using frequency changer, I.F. amplifier, diode, high slope output pentode. It is possible to attain sensitivities of 30 microvolts in production, and the selectivity is adequate for European needs. Hitherto it has been customary to combine the diodes with the output tube, but since the grid of the pentode is taken to the top of the bulb, the rim of the connecting leads is not ideal. (It should be explained that the anode does not go to the

top in view of the danger of a flying lead carrying the maximum power pack voltage and having no appreciable resistance in circuit to limit the current in the event of an accidental short.)

The new tube gives a straightforward layout, the I.F. pentode anode and the diodes being connected through the one valve base, so that the I.F. transformer may be mounted below and the leads kept very short.

♦

Exports of radio apparatus

ACCORDING TO the report of the Department of Commerce, in the month of March, 1935, 1¼-million dollars worth of radio receivers were exported from the United States to various foreign countries. Nearly half a million radio tubes, having a value of \$210,000, were exported during the same period. In addition, nearly half a million dollars worth of radio receiving set components were exported, with \$144,000 value of transmitting sets, tubes and parts. Loud speaker equipment, other than telephone instruments, was exported to the value of \$144,000 during the same period.

♦

Distortion in pentodes

[J. KAMMERLOHER, Berlin.] For many pentodes the plate current can be represented by $I = cE^{3/2}$ or $I = cE^2$, where E is equal to $d_p E_p + d_s E_s - E_g$, or when a signal $e \sin pt$ is applied to the control grid, equal to $d_p E_p + d_s E_s - E_g + e \sin pt$. The value of $d_p E_p + d_s E_s$ is readily found as that value of the grid control bias at which the plate current is practically zero. Developing $c(E + e \sin pt)^{3/2}$ as a power series, the amplitudes of $\sin pt$, $\sin 2pt$ and $\sin 3pt$ are readily found and hence the ratio K of the amplitude of the fundamental to the resultant amplitude of all the frequencies. Restricting the calculation to the single and double frequency, K becomes equal to $e/4E$ for the square law and $e/8E$ for the three-halves power law, or at a given plate potential voltage E_p and screen voltage E_s , it is smaller the lower E_g . The grid bias E_g must, of course, be at least equal to e . The measurements are in fair agreement with this simple theory.—*H. Fr. Tech. El.*

A new British frequency changer

THREE FREQUENCY changer tubes have been popular in British design for the past year or more. These are the pentagrid, octode, and triode-pentode, with fairly equally divided popularity.

The pentagrid has been sponsored by Marconi, Osram and Ferranti, the octode by Philips-Mullard, and the triode-pentode by Ediswan (Mazda). All give about the same effective conversion gain of about .4mA/V, which compares closely with the 6A7 and its equivalents.

But the recent awakening of ultra short wave and television interest has confirmed the fact that none of these tubes is satisfactory at the highest radio frequencies, for various reasons. A survey of the field has therefore led to the development of a type known as the triode-hexode, which has already achieved some success in Germany.

The electrode system and connections of this tube are intended to provide mixing, rectification, and oscillation. The rectifier-mixer section has four grids, two being screens, one the variable mu signal input grid, and the fourth the oscillator coupler which provides electron mixing. This last is connected to the grid of the triode oscillator, built round the lower end of the single cathode.

KING'S REIGN ON RECORDS

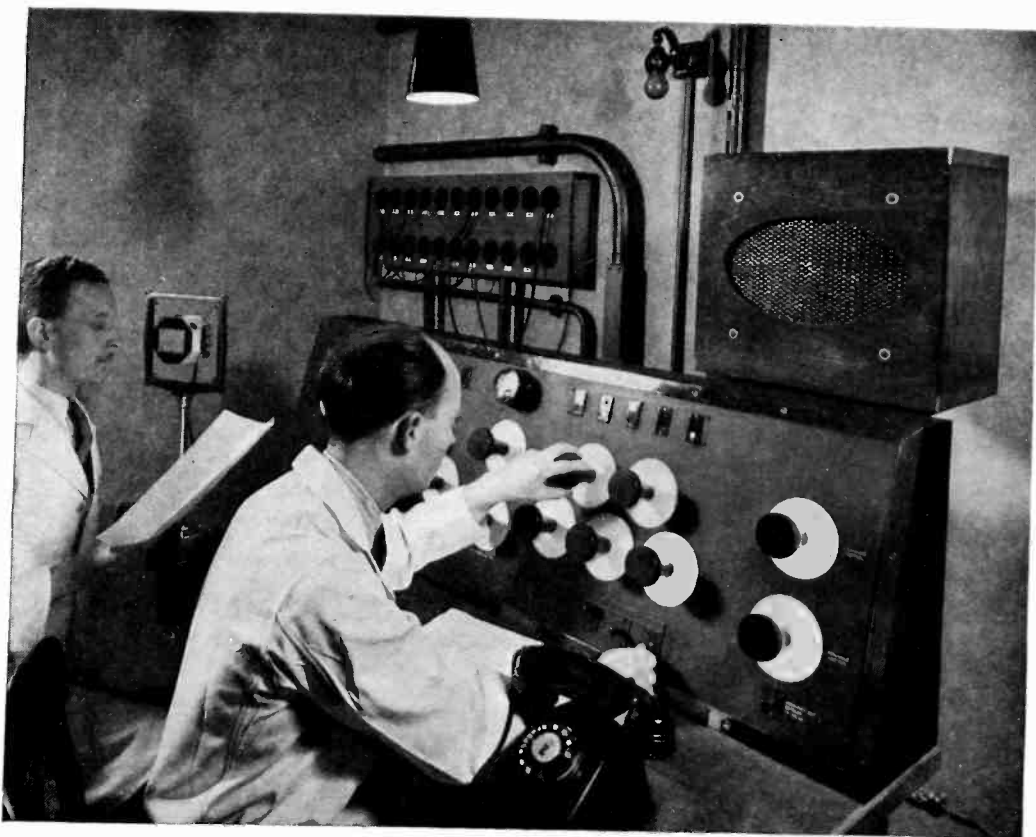

Making Jubilee records in H.M.V. laboratories. Here music, sound effects and artists in 11 studios are mixed and balanced in making a single record

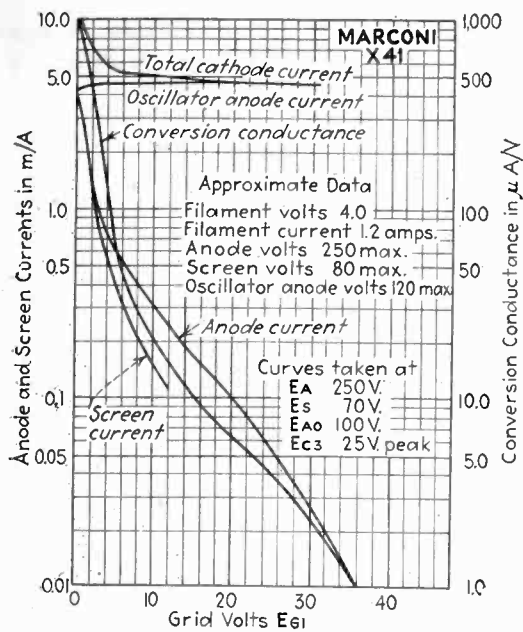

Characteristics of Marconi X-41

Typical performance characteristics are shown in the accompanying curves. The practical conversion gain is about .5mA/V., which is little better than that of the existing types already mentioned, but there are a number of advantages of great interest.

First, the removal of the oscillator anode from the field of the input grid reduces "pulling" to one-tenth of that experienced with the heptode.

Second, it becomes possible to provide a triode oscillator having enough slope to ensure maintenance of adequate r.f. grid volts for full electron modulation up to 50 megacycles. The actual voltage required is 20-25 volts r.m.s.

Third, the electron coupling is accomplished without frequency drift, due to changes of bias on the signal input grid, so that accurate tuning is maintained with varying a.v.c. voltages.

While it is not certain that this tube represents the final word, it appears to have advantages enough to ensure wide popularity.

Television Advances Abroad

Television in France

SINCE THE British television report appeared and Baird's experimental station of the London Crystal Palace started with the radiation of television images by means of ultra-short waves. French television activities have grown tremendously. There was of course always some experimenting with television in France and the system of Monsieur M. Barthélemy of the "Ecole Supérieure des P.T.T." had been shown during the Paris radio show of August 1934 featuring a 30 lines picture. However the picture quality was not attractive.

This state of affairs has now changed. There are now two television stations at present in use in France. Both are of course only experimental ones. The television station of Lyon is working on a wavelength of about 215 meters radiating a 30-line image, the Paris television station, located in the building of the French Post ministry in the Rue de Grenelle, operates on a wavelength of 135 meters, and radiates a picture divided into 60 lines.

In the end of April the French Postmaster General invited several hundred celebrities in the experimental station in the Rue de Grenelle of Paris, and demonstrated to them the 60 lines system of Monsieur Barthélemy. The Parisian society people saw on a screen of about 7 by 10 inches the picture of the very much beloved and admired youthful actress Mlle. Beatrice Bretty from the famous "Comédie Française." Much excitement and applause finished this official demonstration.

The image has been produced via radio pickup as radiated by the 400 watt transmitter. A Nipkow disk scanner with a rapidly travelling spot light was used for the pickup of Mlle. Bretty. The television receiver worked with mirror screw and glow discharge lamp.

Beside these simple television facilities a great 10 kilowatt ultra short wave transmitter is at present under construction. The new transmitter broadcasting on a wavelength of about 7 meters is to broadcast an image of 180 lines. The new station designed by Grammont may later on radiate an image of 240 lines, since all necessary precautions have been made to obtain this change without great difficulties. The antenna for the new television transmitter will be fixed atop the new radio tower of

"Paris P.T.T." at Villejuste, since the new tower is about twenty meters higher than the world famous Eiffel tower.

Television in Italy

IN MILANO, in the northern part of Italy, the first television station has recently been put in use. The new station is equipped with two ultra short wave transmitters, working on a wavelength of 5.05 and 8.00 meters. The radiated pictures are divided into 180 lines. The equipment used for transmission and reception is designed similar to the system developed by Dr. Zworykin of the RCA.

Regular television broadcast in Germany

THE BERLIN television station which broadcast in the past only a program of more or less experimental character, has recently been put in regular use. Since the beginning of April an entertaining program has been broadcast three times a week, on Monday, Wednesday and Thursday, from 8:30 to 10 o'clock p.m. In addition to it the usual experimental program, consisting mostly of older talkies, has been continued. The experimental program is shown daily from 9 o'clock in the morning to 11 o'clock in the night, except Sunday, on which the station is closed. Despite the fact that this experimental program is transmitted in the first place to give factories and experimenters a chance for a check up of new assembled sets, etc., it is very entertaining as reports are indicating.

Two ultra short wave transmitters each of 16 kilowatts are used in the

GERMANY PREPARES FOR COMMERCIAL TELEVISION

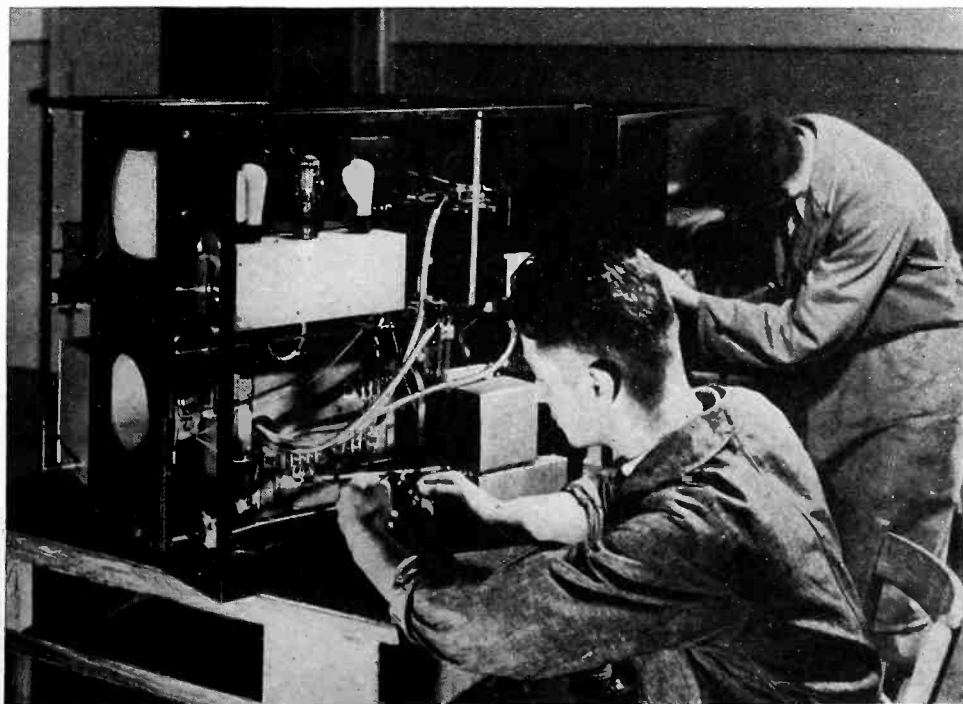

Workers constructing a German Television receiver. Several hundred of these sets have been sold at from \$250 to \$600 each

Berlin television station. The image is radiated on a wavelength of 6.70 meters, while the sound impulses are transmitted on a wavelength of 6.925 meters. Under normal conditions an area of about 25 miles diameter is covered by these transmitters. However, DX reception of about 100 miles was often possible. The picture is transmitted in 180 lines.

The start with the regular broadcast brought a real boom to Berlin radio dealers. 800 sets, the entire stock at this time on the market, have been sold at once. Despite the fact that these television receivers are not cheap (their price is between 300 and 600 dollars), there are at present a considerable number of radio listeners who are willing to pay the price.

To satisfy curiosity, and to propagate television a modern television receiver is kept in operation all the time in the well-known technical collection of the Reichspost Ministerium, located in the heart of Berlin City. It is of course at present the greatest attraction of the entire collection.

While assembled sets are at present not available, very cleverly designed television kits are on sale. These kits consisting of the parts for two ultra short wave receivers, and of a so-called mirror screw with glow discharge lamp for the image reproduction. These sets have only one tuned r.f. stage. Since the Berlin television station radiates the image divided into 180 lines, the mirror screw consists of 180 tiny mirrors arranged like a spindle around the rotating axis. The picture size of such an experimental kit is 4.7 by 5.9 inches only, but the reproduced pictures are of a good quality. However, it seems that only the cathode ray tube has considerable chances in the future, since the receivers with mirror screw are somewhat complicated because of their moving parts.

Estimations as to the amount of receivers which might be distributed in the first television season indicate that about 4,000-6,000 television sets may be sold in the next 8 months. However, under the condition that the cheaper television receivers, price between 250 and 350 dollars, will fulfill the expectations in respect to clear image, and that the radiated programs are attractive enough to amplify the growing interest. In the second season about 40,000 television receivers may be sold if the interest continues to grow.

The cathode ray receivers at present in use have a picture size of about 4 by 6 inches (280 dollar receiver) and up to 10 by 12 inches (list price of about 600 dollars). The pictures produced by this type of receivers are mostly of greenish or bluish color. However, the Telefunken Co. makes also receiver with a black-white image.

As the received program schedules are indicating, very interesting programs have been radiated on the three official evenings. The program started

on each of these evenings with a reproduction of the latest newsreels available, and proceeds with a showing of talkies, specially made for this purpose. Since there is only one picture scanner available at present at the Berlin television station, a short intermission has to be made between the single chapters until the film ribbon for the next chapter is properly adjusted.

Television in Czechoslovakia

According to a statement recently made by a high official of the Czechoslovakian Broadcasting Company television will be added in the near future to normal broadcast, if the financial question and some technical difficulties can be solved. The statement confirms the first television transmitter will be erected in the capitol of Czechoslovakia, in Prague, one of the oldest cities of Europe.

Television in Japan

Television activities in Japan are concentrated in the hand of Professor Kenjiro Takaynagi of the Institute of Technology of Tokio. Professor Takaynagi is using his own system consisting of a combination of a Nipkow disc scanner for the pickup in the studio, and a cathode ray tube reproducer for the image recreation in the receiver. A special feature of the Japanese experimental station is a newly developed electric lamp which produces a light of

high usefulness for direct spot pickup. The new lamp has been made in the factory of the Tokyo Electric Co. and has per unit an illumination power of about 1,000 watts (light units). The picture to be transmitted is scanned into 80 lines. There have been made also experiments with the transmission of talkies. Also these pictures have been cut into 80 lines, 25 frames per second.

Three television development laboratories exist in Japan, at Waseda University near Tokyo, at the Institute of Technology of Hamamatsu (100 miles from Tokyo) and at the Laboratory of the Ministry of Communications.

In Canada

The Department of marine has licensed the Peck Television Company to operate a micro-wave demonstration station at Dominion Square in Montreal. Commander C. P. Edwards, director of radio, states that the station will operate over short distances on frequencies of 50,000 to 54,000 kilocycles.

In Australia

Dr. McDowall in Brisbane has informed the Federal Government that his television tests have advanced to a stage where they justify the expense of a commercial transmitter. He has been allowed use of the wave-length 136 m. for his future transmissions.

X-RAY SERVICE FOR GERMAN FISHING FLEET

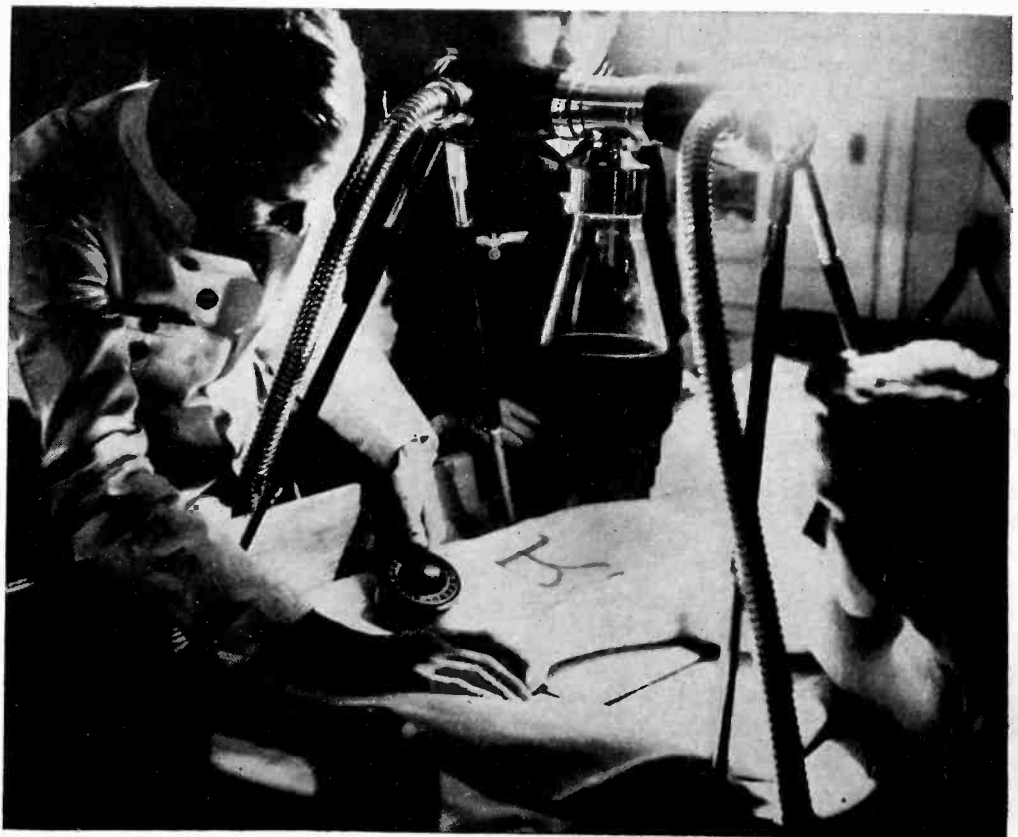

The floating hospital which attends the German fishing fleet has complete X-ray facilities, here shown in use in setting a broken arm

+ NEW PRODUCTS

THE MANUFACTURERS OFFER

Variable coupling i.f. transformers

A NEW intermediate frequency unit has just been developed in the laboratories of the Hammarlund Manufacturing Company, 424 West 33rd Street, New York City. It is a variable coupling

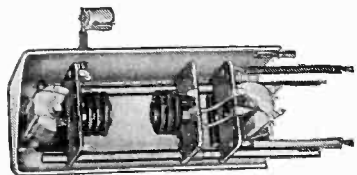

air-tuned intermediate frequency transformer which provides a continuous range of variation from one-third critical coupling to over three times critical coupling. Continuous variation between these limits may be controlled from the receiver panel by means of an ingenious mechanical arrangement. Where continuous variation is not necessary, the coupling may be adjusted to the desired value and locked at that point by means of a collar and set screw provided for that purpose.

Both the primary and secondary are thoroughly impregnated three-pie Litz windings having the high "Q" of 130—a power factor less than .008. The tuning condensers are the familiar Hammarlung midget air-dielectric type and are located on the sides of the can at top and bottom. The construction of the coils and the air condensers affords stability, regardless of humidity or temperature. The transformers may be used with any screen grid tubes normally used as I.F. amplifiers. Both tuning adjustments are on one side of the aluminum shield which measures 2 in. x 2 in. x 5 in. high.—*Electronics*.

Welding timers

FOR WELDING aluminum, stainless steels, silver, carbonyl and other materials, experience has shown that in order to produce the best welds and at the same time limit the welding impulse to a fraction of a second. In fact, most jobs can be handled with welding periods around 1/50th of a second. The Welding Timer Corporation, Chrysler Building, New York City, makes a timer in three standard sizes—50, 75 and 150-ampere capacity. At 220 volts, line voltage,

these correspond to 10, 15 and 25 kw.

The timer consists of two single-pole contactors connected in series with each other and with the primary of the welder and the vacuum-tube timing circuit. In its initial state, one contactor is open, the other closed.

When the welder pedal is depressed the open contactor closes. In closing it triggers off the timing impulse which opens the second contactor.

Current is thus admitted only during the time interval when both contactors are closed.

The tubes are contained in a compartment and can be examined by removing the cover. The tubes used are radio tubes which can be purchased in any radio store. There is one rectifier (which is in some models an 80 tube, in others a 5Z3), and two 27 type tubes.

The maker furnishes tubes at \$1.50 each. These tubes are operated for 50 hours before shipping. This seasoning process makes the possibility of tube failure quite remote as the great majority of failures occur during the first 50 hours. In case of emergency tubes purchased from a radio store may, however, be used.—*Electronics*.

Public address amplifier

THE RADOLEK COMPANY, Chicago, announces a new high quality all-purpose model medium power public address amplifier. This amplifier was especially designed for the medium sized installation in which higher power and therefore necessarily more costly amplifiers are not necessary. The unit is flexible, allowing the use of carbon, capacity, dynamic or velocity microphones—operating up to 7 dynamic speakers—provided with complete plug-and-socket—input and output connections—two input channels with complete mixing and fading equipment—hum-free—equipped with tone control and with a flat frequency characteristic curve from 100-7,000 cycles.—*Electronics*.

Machinable plastic insulation

FOR MOLDED plastic parts requiring sanding or machining operations and subsequent re-polishing, General Plastics announces a new Durez material, called 114 SB black. Telephones, instru-

ment cases, machine parts and many decorative objects are sometimes partially machined or sand-buffed for certain reasons, and on ordinary molding materials the sanding or buffing will uncover flecks of the fibrous filler and in general spoils the color. This new Durez material, however, has a greater depth of color, and a peculiar make-up which permits subsequent polishing to a soft, rich, satiny luster even after complete grinding off of the natural surface. It has a flexural strength of 10,000 P.S.I. and compressive strength of 28,000 P.S.I. and molds on regular cycles.—*Electronics*.

Porcelain cased transmitting condensers

A NEW LINE of porcelain encased mica transmitting condensers, designed for amateur, police and small broadcast transmitters, has been brought out by the Cornell-Dubilier Corporation, 4377 Bronx Boulevard, New York. Designated as the Type 86, the line includes thirteen sizes ranging from .00005 mf. to .1 mf., in voltage ratings from 2,000 to 12,500 volts. These new condensers are especially recommended for plate blocking, grid and tank applications. Their power factor is extremely low and

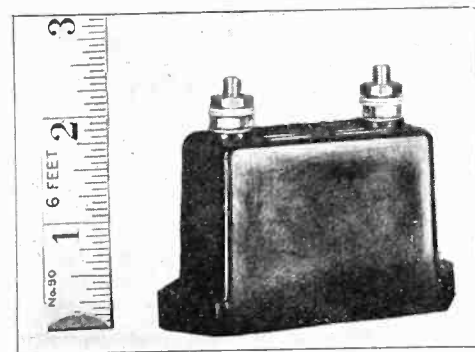

they will carry their full rated load over long periods without heating up.

The mica condenser elements are hermetically sealed in heavy glazed porcelain containers, which are provided with mounting feet and screw terminals. These ceramic cases are not subject to absorption effects when placed near the powerful fields of tank inductors, and they therefore eliminate the appreciable loss that occurs when metal cased capacitors are used in a crowded transmitter.

The net prices of the Type 86 condensers vary from \$2.25 for a 10,000 volt, .0001 mf. unit to \$6.90 for a 3,500 volt, .05 mf. unit.—*Electronics*.

Laboratory mica condensers

MICA CONDENSERS designed for use as secondary standards in laboratory measurements have recently been announced by the General Radio Co., 30 State Street, Cambridge, Massachusetts. Known as type 509 mica condensers, these units are provided in a range from .001 mfd. to 1 mfd. at a price ranging from \$12.50 to \$48.00. The smallest size unit is capable of withstanding a voltage of 700 volts while the .5 and 1 mfd. values are intended for 500 volts maximum. The condensers are mounted in two sizes of cast aluminum cases, measuring $6 \times 3\frac{1}{8} \times 2\frac{1}{8}$ and $4\frac{1}{8} \times 2\frac{1}{2} \times 1\frac{1}{8}$ in. overall. The maximum voltage is specified at various radio frequencies which limit the safe carrying capacity of the unit. The power factor in all



sizes is less than 0.05 per cent, while the temperature coefficient is less than .1 per cent per degree C. The exact value of the capacitance is measured to within .1 per cent and is recorded on the calibration.—*Electronics*.

Two-way loudspeaking telephone system

THE BANK'S RADIO MANUFACTURING COMPANY, 6317 Kenmore Ave., Chicago, announces the marketing of a two-way loud speaking telephone system, which, due to its simplicity and flexibility, make it a practical industrial inter-communication system. It was designed to operate in places where ordinary telephone equipment will not withstand physical and chemical hazards, and where maximum or operating efficiency is required with a minimum of equipment.

This product, "Radio-Tele-Phono," is a combination radio, telephone and phonograph. No microphones, batteries or receivers are used. Two-way conversation can be carried on between any two stations in the net-work.

A party calling from any point in the system can call to any other point on the system. The party answering the call can respond from a distance of ten to forty feet away from the speaking

unit in a normal voice without operating a switch. In this regard also, noises which normally interfere with regular telephonic communication will not carry over this system—that is, the voice always predominates in spite of heavy production noises. This system is not limited to one building or a group of buildings but can be extended along cables for distances of twelve miles or more.—*Electronics*.

B-L rectifiers of copper sulphide type

ON PAGE 134 of the April 1935 issue of *Electronics* rectifiers manufactured by the B-L Electric Manufacturing Co., 19th and Washington Ave., St. Louis, Missouri were stated to be of copper oxide rectifier type, whereas these units are composed of magnesium and copper sulphide composition disks. The copper oxide rectifiers are covered by U. S. Patent No. 1,640,335 assigned to the Union Switch & Signal Company.

Luminous tube transformer for window installations

MODERN streamline design has now entered the transformer field, with the announcement of the Acme Windoette by The Acme Electric and Manufacturing Company, 1455 Hamilton Avenue, Cleveland, Ohio. The Acme Windoette luminous tube transformer has an octagonal housing with end plates that follow the general body design and terminating in a streamline point.

Removable secondary leads, the manufacturer further states, of especially strong, approved high voltage cable are so connected to transformer terminals as to safely support without

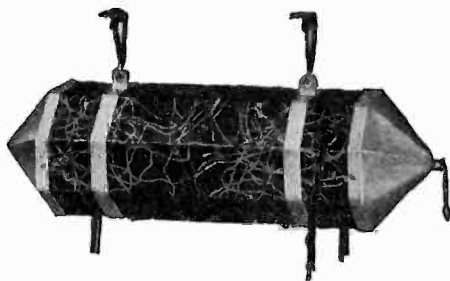

any additional bracing, a skeleton type neon sign weighing up to 100 lbs. However, as an added safety factor, tube holding connection screws are supplied. The Windoette luminous tube transformer is manufactured in a full range of sizes and characteristics to meet the requirements of this type application.—*Electronics*.

Crystal lapel microphone

A NEW CRYSTAL lapel microphone of small dimensions has been announced by Shure Brothers Company, 215 West Huron Street, Chicago, Illinois. The instrument is known as the Model 73A and weighs only $1\frac{3}{4}$ ounces exclusive of the twenty-five feet of shielded cordage which is furnished. Finish is baked rubber-black japan which makes the unit very inconspicuous against the speaker's lapel. A special spring clip is provided for this purpose.

Due to its small size, the new instrument has many other applications in hearing devices, for crime-detection



work, and in laboratory and industrial equipment. The diameter of the unit is only 2 in.; thickness, $\frac{5}{8}$ in. The 73A is licensed under patents of the Brush Development Company and lists at \$25, complete with twenty-five feet of cord.—*Electronics*.

Electro-magnetic counters

THE OHMER REGISTER COMPANY, Dayton, Ohio, manufactures two types of electrically actuated counters which can be used in connection with photo-cell and other electronic apparatus for keeping a record of the number of operations performed. Several years ago the company's engineers did considerable work on a complete photo-cell counting unit, but development of this has been discontinued, and the Ohmer company now limits its products to the counters that are already standard with it for taximeters, fare registers, etc.

The Ohmer 82-A and 82-B electric counters are designed to be operated from a distance by closing an electrical contact, and are adapted for the greatest possible speed. The counter mechanism fits on a demountable back, so that the electrical contacts are made automatically when the counter slips into place. Electromagnets can be provided for operation on 6, 12, 110 and 125 volts, direct current, and 110 volts alternating current. These counters are provided with "trip" indicators, which can be reset; and with a cumulative total indicator which cannot be reset until the counter has reached 99,999, whereupon the figures are reset automatically.—*Electronics*.

Metal tubing for radio tubes

METAL TUBING of great accuracy and in a wide range of sizes, is being produced in large quantities in the new plant of the Superior Tube Company, of which S. L. Gabel is president. The factory is modern in design and equipment and has an unusual location in the open country near Norristown, Pa., where working conditions are ideal, making for the maximum quality of output. An interesting organization policy characterizes the plant, under Mr. Gabel's supervision, by which the men, many of them college graduates, are regarded as associates rather than employees, with freedom of action in matters of reporting time, smoking, etc.

The Superior Tube Company is now one of the largest producers of nickel tubing for the radio industry, and the uniform quality of its output is assured by the modern methods employed in all plant processes such as annealing, drawing, cleaning, etc. All commercial sizes of nickel tubing are processed, and partly-manufactured material is kept in stock, so that hurried orders can be filled promptly and with minimum delay. Among the interesting examples of fine work turned out by the plant, were recent drawings of nickel tubing down to ten one-thousandths of an inch in outer diameter, with walls only 18 10,000ths of an inch thick.

The company is also turning out quantities of metal exhaust tubes for the new-all-metal radio tubes, and with its skilled workmen and large equipment of drawing machines, furnaces, etc., is able to meet any requirements in tube production called for by the radio industry. Mr. Gabel is himself a widely experienced tubing manufacturer, having been associated with the small-tube industry for thirty years, of which twenty years have been in active operating work. The Superior Tube Company invites interested radio engineers to visit its unique plant, the mail address of which is P. O. Box 227, Norristown, Pa.—*Electronics*.

Electrolyte for condensers

A DEPARTURE from usual electrolytic condenser chemistry is responsible for condenser performance claims made by Henry L. Crowley & Company of West Orange, New Jersey. After several years of research, this organization has evolved a new electrolyte said to be a single chemical, instead of the usual mixture of chemicals and a carrier. The single chemical cannot settle out or precipitate, and therefore remains in a stable state. This makes for uniform and maintained characteristics throughout long condenser life. The new elec-

trolyte not only protects the oxide film on plate or plates, but actually rebuilds the dielectric film in the event of over-voltage breakdown. Thus the condenser is said to be self-healing, even at peak voltage operation.

Also, the electrolyte is said to permit condensers to be operated at higher working voltage than that at which the foil was originally formed. Leakage is low, such as 0.2 milliamperes for an 8-mfd. 450 volt section. Life tests point to long service with well maintained characteristics.—*Electronics*.

All-wave coupler

WITH THE approach of summer with its increased static and interference of all kinds, the Muter Company of Chicago has brought out a new All-Wave Tuning Coupler to meet the demand for an efficient yet inexpensive unit to match up any radio set with a doublet antenna system of the type now meeting with widespread approval. The Muter Tuning Coupler is an all-wave device in that it is equally efficient on both the short wave bands and the 200 to 550 meter broadcast band.

Changeover from short wave to broadcast reception is accomplished instantly



by means of a simple switching arrangement eliminating the necessity of changing connections in any way.—*Electronics*.

R-f circuit hook-up wire

A NEW TYPE of hook-up wire, designed particularly for connections in the radio frequency circuits of radio receivers, has been announced by the Lenz Electric Manufacturing Company, 1751 North Western Avenue, Chicago, Ill. This wire, according to the manufacturer, has exceptionally low losses, high insulation resistance, low moisture absorption, particularly at the high frequencies (10 mc and above).—*Electronics*.

Electronic laboratory service

HARRY ROSENTHAL has equipped a laboratory at 114 East Thirty-second street, New York City, to do general electronic work, including high-vacuum

pumping, electronic and gaseous-tube experimental construction, and technical glass blowing, for clients interested in carrying out electronic experimentation. The new laboratory is being conducted under the name of "Rolab." — *Electronics*.

Modulation meter

A MODULATION METER embodying new features has just been introduced by the Radio Research Co., Inc., 9th & Kearny Sts., N.E., Washington, D. C. This instrument is intended for continuous monitoring of the program of a broadcasting station. A new type of meter having an exceptionally fast movement indicates the modulation percentage. This modulation percentage indicator is graduated "0-110% modulation" and also is graduated in decibels, with 100% modulation as the reference point. This additional scale is particularly useful to the station engineer in making frequency and amplitude characteristic runs on the transmitter and in setting up the audio levels to be maintained at the studio. Another meter on the panel indicates carrier amplitude and carrier shift. The instrument is self-contained and a-c operated. Both positive and negative peaks can be read.—*Electronics*.

Small-size electrolytic condensers

IT IS A WELL KNOWN fact that the capacity of dry electrolytic condensers is directly proportionate to the foil area used in making the condenser winding. In taking advantage of increased area in electrolytic condenser manufacture greater compactness may be achieved. There has been difficulty, however, in finding ways and means to make electrolytic condensers with roughened anode plates without sacrificing power factor and leakage characteristics. A new series of condensers of this type have appeared. The new Solar series of dry electrolytics are aptly named "Little



Giants." They are about half the size of previous "midget" types. Two voltage ranges are available, 450 volts and 200 volts working, in all usual capacities. Thickness has been kept to a minimum, so that these condensers will fit anywhere—for rapid repairs. The manufacturer is Solar Manufacturing Corporation, 599-601 Broadway, New York City.—*Electronics*.

U. S. PATENTS IN THE FIELD OF ELECTRONICS

Radio circuits and apparatus

High frequency oscillator. Device for producing ultra-high frequency oscillations by providing a stream of electrons traveling in a curved path so as to cross itself. C. W. Hansell, R.C.A. No. 2,001,133.

Tuned radio receiver. Several circuits simultaneously tuned by a lever device. H. M. Lewis, R.C.A. No. 2,001,146.

Iron core coil. High-frequency coupling device with a ferro-magnetic core for primary and secondary winding, said cores being adjacently and coaxially disposed and relatively adjust-

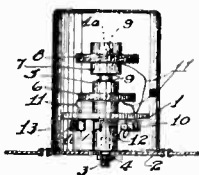

able, whereby the magnetic coupling between primary and secondary may be conveniently adjusted to any desired value. Alfred Crossley and H. E. Meinema, Johnson Laboratories, Inc. No. 2,002,500.

Remote control. Using power lines by generating at a point on the power lines remote from the receiver high frequency oscillating currents of fixed

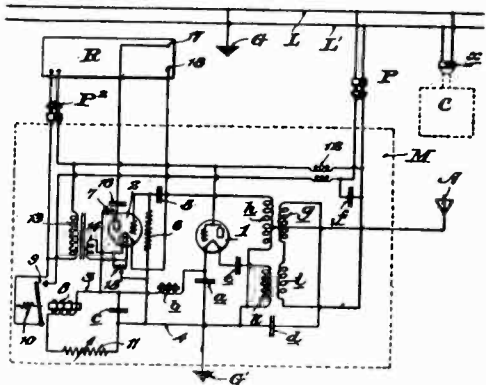

frequency and using variable different frequencies for the purpose of turning the receiver off or on. A. S. Blatterman, Asbury Park, N. J. No. 2,003,877.

Down-lead. A system for protecting a radio receiver from interference. J. G.

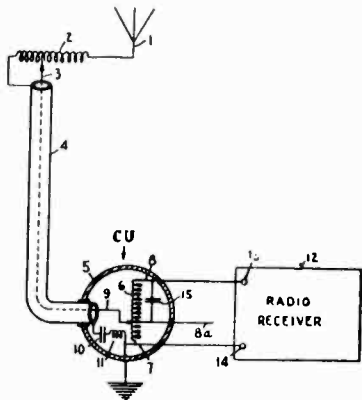

Aceves and E. V. Amy. No. 2,002,844.
Electron turbine. An electron tur-

bine comprising an electron emitter and a rotor concentrically mounted with respect to said emitter, and an anode concentrically surrounding said emitter and rotor. A. B. Dumont, Upper Montclair, N. J. No. 1,999,407. See *Electronics*, August, 1930.

Tube tester. Power supply circuit to provide plate and grid circuit voltages for a tube to be tested. J. R. Barnhart, Lakewood, Ohio. No. 1,999,858.

Tube testing apparatus. Means for audibly stimulating the effect of a defective tube's operation in a radio receiving set comprising audible reproducing mechanism, means for prolonging the effect of transient impulses, comprising an oscillatory circuit and means for rectifying and conveying to the mechanism oscillations produced by defects in a tube under test. R. O. Hurd and T. E. Hodgkinson, San Francisco. No. 2,000,595.

Amplification, generation, detection, etc.

R-f amplifier. Operating a cascade amplifier having successive circuits tuned to the same frequency by intermittently applying to the elements of the tube potentials tending to cause tube operation at efficiency so high as to tend to cause oscillation, and varying the potential intermittently upon one element to prevent oscillation. F. A. Parsons, Milwaukee, Wis. No. 2,005,237.

Anti-distortion amplifier. An amplifier of the type in which distortion occurs at low amplification and in which means are provided for controlling over a wide range the amplitude of pulsations in the output circuit resulting from pulsations impressed upon the input, means for effecting linear amplification throughout the controlling range by impressing the signal energy across the input terminals of a pair of tubes, and adjusting the energizing potentials upon the respective tubes to effect non-linear amplification at different rates, and delivering amplified outputs from the tubes to a common output circuit in phase opposing relation. P. O. Farnham and Raymond Asserson, R.C.A. No. 2,005,080.

Constant amplitude amplifier. A multi-tube amplifier with means for producing a constant amplitude and wave shape output irrespective of the wave shape and amplitude of the supplied energy. Henry Shore, R.C.A. No. 2,005,111.

Regenerative amplifier. Multi-tube circuit with the input coupled to the output to create a tendency for the feedback, means for preventing the feedback of energy from the output circuit to the input, etc. E. L. Bowles, Wellesley Farms, Mass. No. 2,004,155.

Television transmission, etc.

Scanning method. Signals as to light and shade are obtained in one code and rearranged and transmitted as a part of a different code. M. D. McFarlane, New York, N. Y. No. 2,002,208.

Facsimile system. W. G. H. Finch, Washington, D. C. 47 claims. Filed

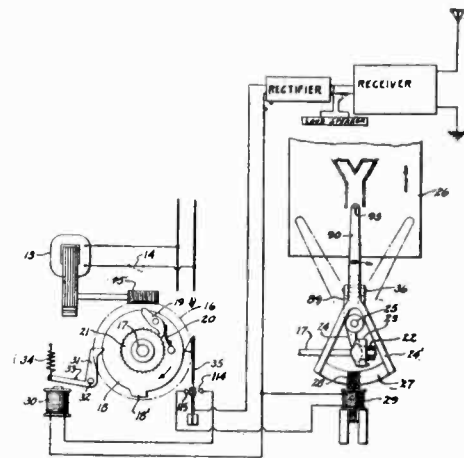

Dec. 25, 1934. Three issues. No. 19,575.

Viewing panel. Electro-optical image reproductions are made on a panel by means of several light sources. H. M. Dowsett, R.C.A. No. 2,002,937.

Color television. A lens system to polarize light. R. H. Worrall, Washington, D. C. No. 2,002,515.

Scanning system. A rotatable element carrying fixed thereon several concave cylindrical reflectors whose axes of curvature are contained in planes common to their axis of rotation. H. P. Donle, Radio Inventions, Inc. No. 2,002,992.

Scanning system. Method of unidirectionally scanning motion pictures for television purposes. Oscar A. Ross, New York, N. Y. No. 2,002,678.

Television system. A glow discharge lamp for applying voltage to the lamp, etc. Application Nov. 2, 1927. Renewed June 22, 1931. 19 claims. J. W. Horton, B.T.L., Inc. No. 2,003,294.

Color television. Apparatus for producing an image in color from a color record. H. E. Ives, B.T.L., Inc. No. 2,001,730.

Electron tube applications

Anti-glare apparatus. Method for protecting the eyes of a motor vehicle driver from the blinding action of illuminants, such as the headlights of an approaching vehicle. A photo cell in-

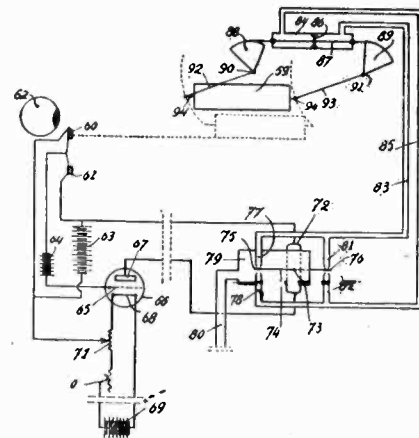

tercepts the oncoming lights and moves a protecting screen in the form of a narrow strip in front of the driver's eyes. Constantin Chilowsky, Paris, France. No. 2,003,248.

Electrosurgical apparatus. A vacuum tube oscillator, spark gap oscillator, etc. R. H. Waxson, Burdick Corp. No. 2,002,119.



" JUST MEETING SPECIFICATIONS "

ERIE Resistors have never failed to meet any standard specifications of radio receiver manufacturers.

But, far from being satisfied with just meeting these requirements, a competent staff of engineers are constantly improving the performance of these products through continued research and experiment. As a result, Erie Resistors have, today, consistently smaller changes in their resistance values due to operating conditions than any other make.

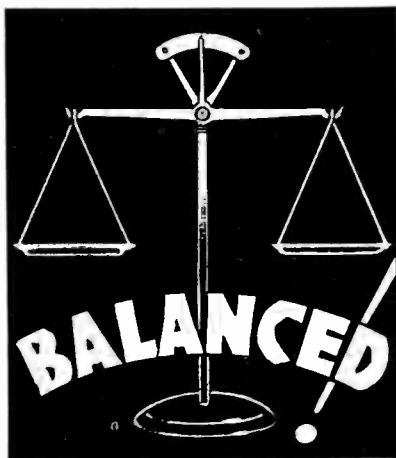
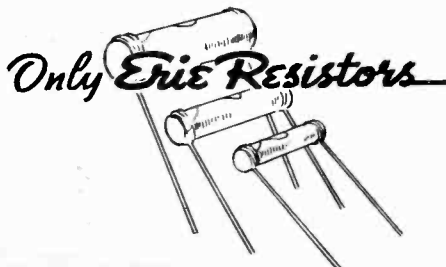

Recent exhaustive tests point out that several types of resistors—all of which pass most set manufacturers' standards—have from 10% to over 500% greater variation than Erie Resistors in four of the following characteristics; voltage coefficient, temperature coefficient, and humidity, load and noise characteristics.

Switch to Erie Resistors 100% for greater efficiency. You can depend on their balanced trouble-free operation.



ERIE RESISTOR CORPORATION

ERIE, PA.

Factories in ERIE, PA. - TORONTO, CANADA - LONDON, ENG.

Electrical musical instrument. Patent to John Hays Hammond, Jr., Gloucester, Mass. No. 2,001,722-2,001,724, inclusive. See also 2,001,391 and 2,001,392 to B. F. Miessner, on electrical musical instruments.

Spark plug system. An impulse spark generating system comprising a recti-

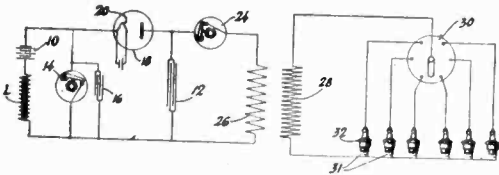

fier tube. D. W. Randolph and Hector Rabezzana, General Motors Corp. No. 2,003,466.

Flame control. Grid glow tube control of a fluid fuel supply system for high temperature flame. G. D. Bower, Minneapolis-Honeywell. No. 2,003,624.

Grading apparatus. Means for grading construction materials having a moisture content, such as a number of pieces of lumber, comprising a vacuum tube; grid bias is varied by the moisture of the apparatus being tested. T. E. Heppenstall, Long-Bell Lumber Co. No. 2,003,077.

Color comparator. A photoelectric device for measuring the light absorbing

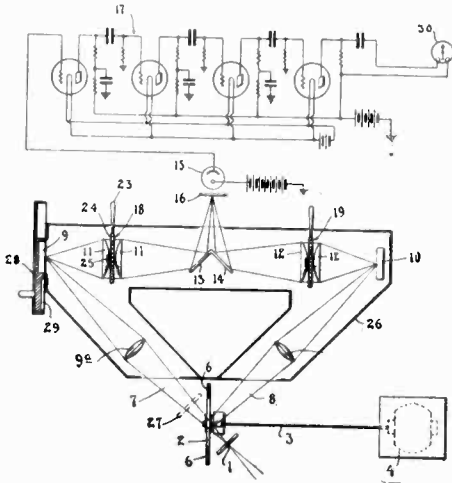

factor of an object. C. H. Sharp, E.T.L., Inc. No. 1,999,023.

Therapeutical apparatus. Vacuum tube apparatus for producing graduated involuntary muscular contractions. J. S. Kinney, Westinghouse X-Ray Co. No. 1,999,729.

Magnetostrictive vibrator. Patent No. 2,000,024 to 2,000,026, to J. M. Ide, Cambridge, Mass.

Electrical precipitation. Patent No. 2,000,018 to 2,000,020, to Richard Heinrich, International Precipitation Co., Germany.

Patent suits

T. M. 210,122, Victor Talking Machine Co., Radio apparatus, parts, and appurtenances; T. M. 215,794, same, Talking machine, and parts thereof, records, D. C., N. D. Ill., E. Div., Doc. 14,314, R. C. A. Mfg. Co., Inc., v. Victor Radio Corp. et al. Consent decree holding infringement Feb. 18, 1935.

1,403,475 (a), H. D. Arnold, 1,403,932, R. H. Wilson, 1,507,016, L. de Forest; 1,507,017, same; 1,618,017, F. Lowenstein; 1,702,833, W. S. Lemmon; 1,811,095, H. J. Round; Re. 18,579, Ballantine & Hull, D. C., N. D. Ill., E. Div.,

Doc. 14252, Radio Corp. of America et al. v. F. M. Lund et al. (Capitol Radio Co.). Consent decree holding patents valid and infringed Jan. 16, 1935.

1,403,475 (b), H. D. Arnold, 1,403,932, R. H. Wilson; 1,507,016, L. de Forest; 1,507,017, same; 1,618,017, F. Lowenstein; 1,702,833, W. S. Lemmon; 1,811,095, H. J. Round; Re. 18,579, Ballantine & Hull; Re. 18,916, J. G. Aceves, D. C., N. D. Ill., E. Div., Doc. 14256, Radio Corp. of America et al. v. Levinson Radio Stores Co. et al. Consent decree, holding patents valid and infringed Feb. 27, 1935.

1,403,475 (c), H. D. Arnold; 1,403,932, R. H. Wilson; 1,618,017, F. Lowenstein; 1,702,833, W. S. Lemmon; 1,811,095, H. J. Round; Re. 18,579, Ballantine & Hull; Re. 18,916, J. G. Aceves, D. C., N. D. Ill., E. Div., Doc. 14268, Radio Corp. of America et al. v. Atlas Sports & Radio Co. et al. Consent decree holding patents valid and infringed Feb. 16, 1935. Doc. 14,270, Radio Corp. of America et al. v. J. P. Winnecour (Economy Tire & Radio Stores). Decree as above Jan. 28, 1935.

1,231,764 (a), F. Lowenstein; 1,618,017, same; 1,403,475, H. D. Arnold; 1,403,932, R. H. Wilson; 1,465,332, same; 1,573,374, R. A. Chamberlain; 1,702,833, W. S. Lemmon; 1,811,095; H. J. Round; Re. 18,579, Ballantine & Hull, D. C., N. D. Ill., E. Div., Doc. 13757, Radio Corp. of America et al. v. International Parts Corp. et al. Consent decree holding patents valid and infringed Feb. 5, 1935. Patent 1,231,764 is not mentioned in the decree.

1,231,764 (b), F. Lowenstein; 1,618,017, same; 1,403,475, H. D. Arnold; 1,403,932, R. H. Wilson; 1,465,332, same; 1,702,833, W. S. Lemmon; 1,811,095, H. J. Round; Re. 18,579, Ballantine & Hull, D. C., N. D. Ill., E. Div., Doc. 13842, Radio Corp. of America et al. v. S. P. Zaney et al. Decree pro confesso as to defendants Zaney & Gill Oct. 3, 1934. Consent decree as to Rabinovitch, holding patents valid and infringed Jan. 15, 1935.

1,247,540, 1,247,542, Re. 15,140, 1,286,017, W. Jones.

1,403,475, H. D. Arnold, Vacuum tube circuit; 1,811,095, H. J. Round, Thermionic amplifier and detector; 1,403,932, R. H. Wilson, Electron discharge device; 1,936,162, R. A. Heising, Transmission system; 1,702,833, W. S. Lemmon, Electrical condenser, filed Apr. 16, 1935, D. C., S. D. N. Y., Doc. E 80/142, Radio Corp. of America, et al. v. Lenox Engineering Co., Inc., et al.

1,374,679, J. B. Pratt, Degasifying process; 1,537,708, W. Schottky, Thermionic vacuum tube; 1,558,437, I. Langmuir, Electrical discharge apparatus; 1,696,103, G. Seibt, Electric discharge tube; 1,855,885, A. W. Hull, Electron discharge device, filed Apr. 11, 1935, D. C., E. D. N. Y., Doc. E 7571, Radio Corp. of America et al. v. Ampere Electronic Products, Inc., et al.

1,251,377 (a), A. W. Hull; 1,297,188, I. Langmuir; 1,477,898, C. W. Rice, D. C., N. D. Ill., E. Div., Doc. 13758, General Electric Co. v. International Radio Parts Corp. et al. Consent decree holding 1,297,188 and 1,477,898 valid and infringed Feb. 5, 1935. Patent 1,251,377 is not mentioned in the decree.

1,251,377 (b), A. W. Hull; 1,297,188, I. Langmuir; 1,573,374, P. A. Chamber-

lain; 1,728,879, Rice & Kellogg, D. C., N. D. Ill., E. Div., Doc. 13843, Radio Corp. of America et al. v. S. P. Zaney et al. Decree pro confesso as to defendants Zaney & Gill, Oct. 3, 1934. Consent decree as to Rabinovitch holding patents valid and infringed Jan. 15, 1935.

1,251,377 (c), A. W. Hull; 1,297,188, I. Langmuir; 1,573,374, P. A. Chamberlain; 1,707,617, 1,795,214, E. W. Kellogg; 1,894,197, Rice & Kellogg, same, D. C., N. D. Ill., E. Div., Doc. 14253, Radio Corp. of America et al. v. F. M. Lund et al. (Capitol Radio Co.). Consent decree holding patents valid and infringed Jan. 16, 1935.

1,251,377 (d), A. W. Hull; 1,297,188, I. Langmuir; 1,573,374, P. A. Chamberlain; 1,707,617, 1,795,214, E. W. Kellogg; 1,894,197, 1,728,879, Rice & Kellogg, D. C., N. D. Ill., E. Div., Doc. 14257, Radio Corp. of America et al. v. Levinson Radio Stores Co. et al. Consent decree holding patents valid and infringed Feb. 27, 1935, Doc. 14269, Radio Corp. of America et al. v. Atlas Sports & Radio Co. et al. Decree as above Feb. 16, 1935. Doc. 14271, Radio Corp. of America et al. v. J. P. Winnecour (Economy Tire & Radio Stores). Decree as above Jan. 28, 1935.

1,825,598, H. Vogt, Process for producing combined sound and picture films, D. C., S. D. N. Y., Doc. E 79/68, American Tri-Ergon Corp. v. First Division Pictures, Inc. Dismissed without prejudice (notice Apr. 10, 1935). Doc. E 79/78, American Tri-Ergon Corp. v. Monogram Pictures Corp. Decree as above. Doc. E 79/102, American Tri-Ergon Corp. v. Cinelab, Inc. Decree as above. Doc. E 79/98, American Tri-Ergon Corp. v. Producers Laboratories, Inc. Dismissed without prejudice (notice Apr. 15, 1935). Doc. E 79/99, American Tri-Ergon Corp. v. Malcolm Laboratories Corp. Decree as above. Doc. E 79/72, American Tri-Ergon Corp. v. Consolidated Film Industries, Inc. Doc. E 79/77, American Tri-Ergon Corp. v. Ameranglo Corp. Doc. E 79/100, American Tri-Ergon Corp. v. H. E. Laboratories, Inc. Doc. E 791/101, American Tri-Ergon Corp. v. Filmlab, Inc. Dismissed without prejudice (notice Apr. 16, 1935), in each of above cases. Doc. E 79/180, American Tri-Ergon Corp. v. C. D. Hilles et al. Dismissed without prejudice (notice Apr. 25, 1935). Same, D. C., E. D. N. Y., Doc. E 7400, American Tri-Ergon Corp. v. Warner Bros. Pictures Inc. et al. Dismissed without prejudice Apr. 30, 1935. Same, D. C., S. D. N. Y., Doc. E 79/66, American Tri-Ergon Corp. v. Columbia Pictures Corp. Dismissed without prejudice (notice Apr. 29, 1935). Same, filed Oct. 17, 1934, D. C., S. D. N. Y., Doc. E 79/69, American Tri-Ergon Corp. v. Metro-Goldwyn-Mayer Corp. et al. Doc. E. 79/70, American Tri-Ergon Corp. v. Universal Pictures Corp. Same, filed Oct. 18, 1934, D. C., S. D. N. Y., Doc. E 79/76, American Tri-Ergon Corp. v. Twentieth Century Pictures, Inc. Doc. E 79/79, American Tri-Ergon Corp. v. Reliance Pictures, Inc. Same, filed Oct. 23, 1934, D. C., S. D. N. Y., Doc. E 79/103, American Tri-Ergon Corp. v. Du Art Film Laboratories, Inc. Same, D. C. Dela., Doc. E 925, American Tri-Ergon Corp. v. R. K. O. Radio Pictures, Inc. Dismissed Apr. 24, 1935.

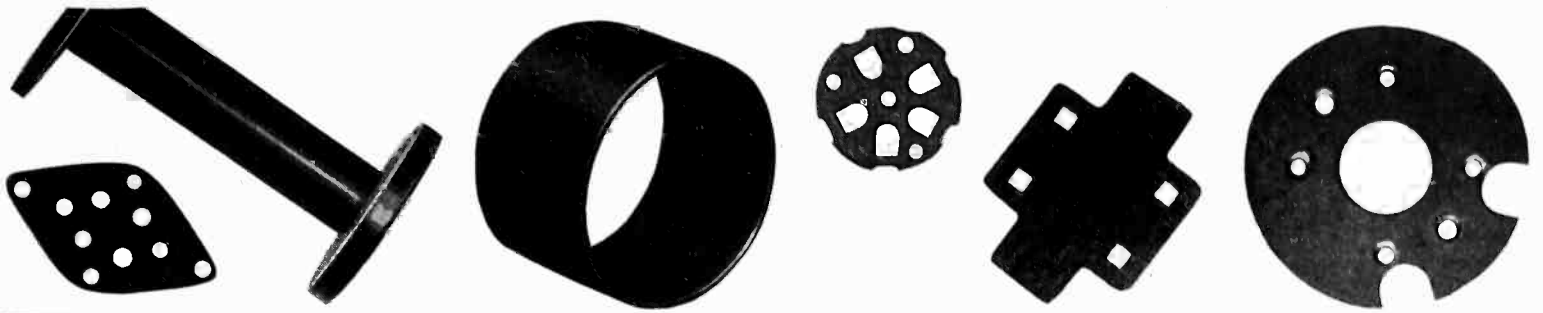

FORMICA IS RIGHT- FOR ANY INSULATING PART!

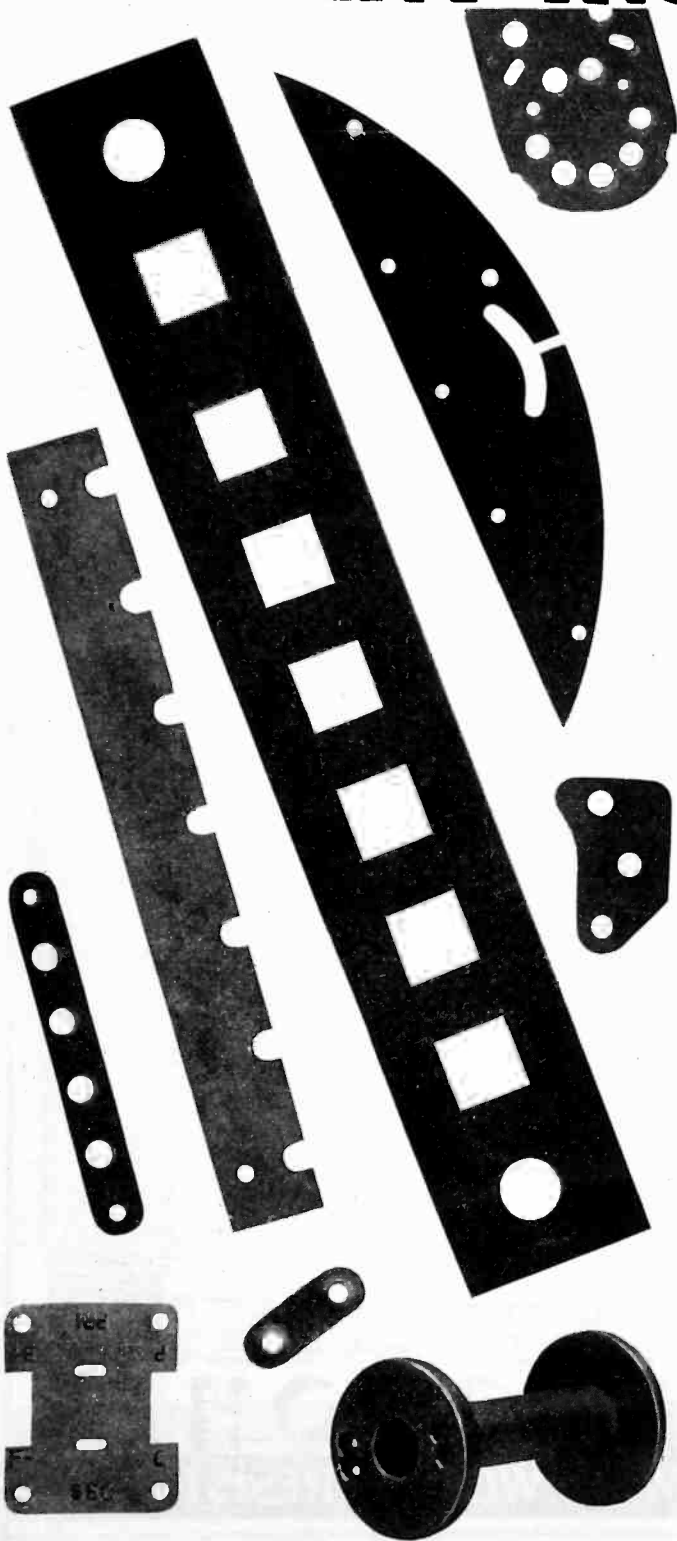

FOR all insulating parts in which laminated phenolics are suitable a grade of Formica is available which will exactly meet the requirements.

For twenty-two years the Formica laboratories have been working out special types and grades to meet specific situations and the formulas are here and ready when you need something special.

For instance Formica now has a product in which metal is inlaid in insulating sheet providing a combined insulator and conductor which occupies very little room, saves space, and gives you a very durable set up where moving contacts are employed.

Let Formica engineers assist with your problems.

THE FORMICA INSULATION CO.

4638 Spring Grove Avenue, Cincinnati, Ohio

FORMICA

GOAT

FORM-FITTING TUBE SHIELDS



New Type



Easily
Mounted

≈
≈
Economical

≈
≈
and
Effective

*Bulletins, samples and prices
on request.*

GOAT RADIO TUBE PARTS, INC.

314 Dean Street, Brooklyn, N. Y.

(A Division of FRED GOAT CO., Inc., Est. 1893)

43 E. Ohio St., Chicago

200 N. Edgemont Ave., Los Angeles, Calif.

500 King St. West, Toronto, Canada

New

REMLER AP3-18

MODERNIZES REMOTE PICK-UPS

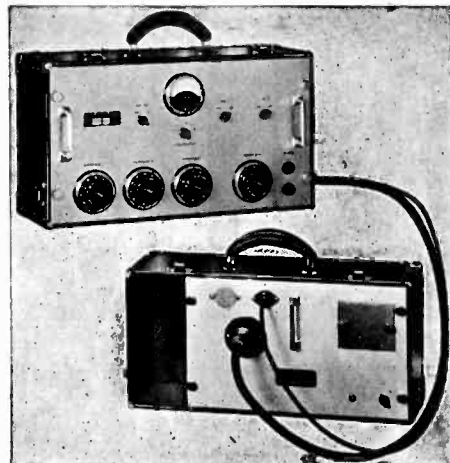

- High Gain
- High Fidelity
- Compact
- Portable
- No Batteries
- Attractive
- Moderate Price

High gain Remote Amplifier and Power Supply, designed for use with three Dynamic, Velocity or Inductor microphones and also in a type for operation with the above in combination with condenser microphones. Compact, high fidelity system incorporating refinements ordinarily associated with studio equipment. Three channel input with individual attenuators and master gain control. Feeds two broadcast loops simultaneously. 50 or 200 ohm input units connected by 6' cable and lock-type plugs. AC or battery operation. Overall gain 95 DB. Tubes 2-77; 1-79; 1-6A6 and 1-80. Used and endorsed by leading broadcast stations. Write for catalogue sheets. List price \$365.00.

REMLER COMPANY, Ltd.

2101 Bryant Street

San Francisco, Calif.

REMLER—THE RADIO FIRM AS OLD AS RADIO

GUTHMAN Coils

Coils for every purpose—to your specifications—guaranteed within any tolerances you wish—at the most favorable prices in coil history. Send in your specifications for samples.

EDWIN I. GUTHMAN and CO., Inc.
1036 West Van Buren St., CHICAGO, ILLINOIS

This midget RESISTOR does a BIG job well!

Our type "R" MICROHM ½-watt Resistor shown here, actual size, is ideal for Analyzer, meter conversion and many other uses, where a compact, low-priced Resistor is required. Resistance up to 500,000 ohms. Companion to above unit is our type "S" 1 watt, which may be obtained in resistance values up to 1 Megohm. Write for samples, further information and our new catalog.

PRECISION RESISTOR CO.

334 Badger Ave., Newark, N. J.

MICROHM

WIRE WOUND RESISTORS



YOU CAN STRENGTHEN YOUR PRODUCTS WITH TEXTOLITE

CHECK THE ADVANTAGES THIS LAMINATED MATERIAL PROVIDES

Textolite laminated is a strong material having high insulating qualities. It does not warp or shrink, and its insulating qualities are not affected by atmospheric conditions. No matter

how delicate a device is, the inclusion of Textolite in its construction will give it strength, low ground leakage, and proper insulation of charged circuit parts.

✓ CHECK THESE SPECIFICATIONS Point by Point WITH YAXLEY SHORT WAVE SWITCHES

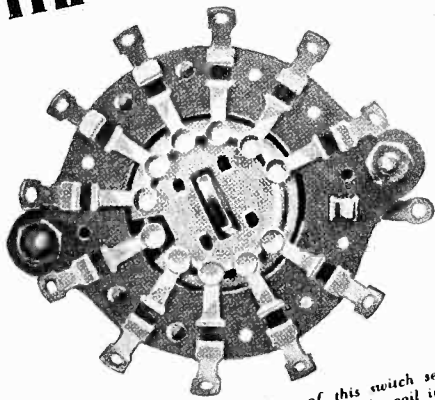

The shorting rotor plate of this switch section short circuits all the coils except the coil in use, thus eliminating coil absorption.

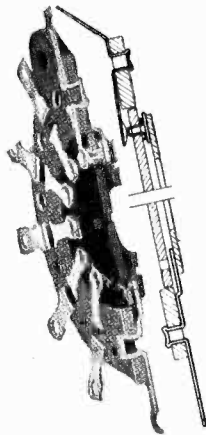

A Yaxley short wave switch section that has been cut in half with the cross-section drawing showing in heavy outline the heavy silver plating on all metal parts which assures lowest possible contact resistance.

Samples will be sent promptly upon receipt of a sketch or description of your requirements.

Specifications	Yaxley Features
1 Low, uniform and unchanging contact resistance.	"Silver to silver" contacts insure exceedingly long life and lowest possible contact resistance.
2 Imperviousness to atmospheric conditions.	Moisture absorption.
3 Low capacity to ground	Shielding to ground.
4 Elimination of coil absorption.	Various types of coils, except the coil in use.
5 Adaptability of all circuit arrangements.	Flexibility in coil and switch combinations for all circuit arrangements found in 1935 receivers.
6 Smooth operation with positive indexing action.	The finest quality of special metal springs and other metal contacts assure smooth mechanical performance.
7 Proper shielding of circuits and coils.	Shielding to minimize coupling.
8 Compactness of design	Switch can be mounted in a chassis base or between equipment where space is at a premium.
9 Rugged construction to insure long life.	Low contact resistance.

For information as to the adaptability of Textolite to your needs, write Plastics Department, General Electric Company, West Lynn, Mass.

YAXLEY MANUFACTURING CO.
INCORPORATED
Division of P. R. Mallory & Co., Inc.
INDIANAPOLIS, INDIANA

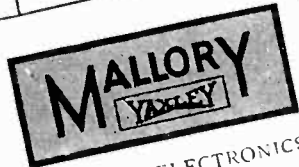

April 1935 — ELECTRONICS

GENERAL ELECTRIC

942-39

Here's a New Inductance Bridge You Should Know More About

Check these New Design and Performance Features

- ★ Accurately measures small inductors of very low Q (viz.; Q of .006 for 100 μ h).
- ★ With external standard, measures large inductors to 1,000 h.
- ★ Measures resistance of inductors . . . particularly useful in measuring ratio of a-c to d-c resistance up to 50 kc.
- ★ Direct reading from 1 μ h to 1h over a frequency range of 60 to 10,000 cycles.
- ★ Exceptionally accurate: 0.2% or to 0.1 μ h, whichever is the greater.
- ★ Resistance decades inductively compensated.
- ★ Inductance and resistance balances entirely independent.

Developed for radio coil and receiver manufacturers for the measurement of inductance of small coils with very low values of Q, the new Type 667-A Inductance Bridge, in addition to this specialized application, is a very useful general-purpose inductance bridge. Its range and accuracy are more than sufficient for all commercial laboratory measurements.

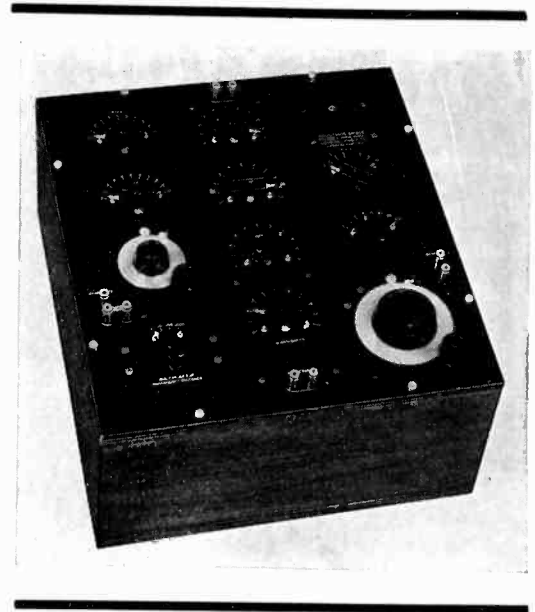

Type 667-A Inductance Bridge . . . Price: \$325.00

Write for complete details . . . ask for Bulletin EX-3403-E

GENERAL RADIO COMPANY

30 State Street

Cambridge A, Massachusetts



Experience — which insures success to the last step in tube production



BEHIND the NEW Barex Embedded Getter is the specialized experience of an organization whose entire efforts are concentrated on the development and production of just one product—a GETTER which can be depended on to vaporize completely, with minimum splash—a GETTER which reduces shrinkage, increases production and cuts costs of both material and labor.

All these advantages are proved in the production of manufacturers of quality vacuum tubes. Ask us for details.

**KING LABORATORIES
INC.**

**205 ONEIDA STREET
SYRACUSE NEW YORK**

*The NEW
BAREX Embedded GETTER*



Space-Saving RESISTORS



AEROVOX Pyrohm Jr. Resistors . . . just what name implies: Smaller wire-wound vitreous-enamel resistors capable of big work in small bulk. 5, 10, 15, 20 watt ratings. Accurate. Noiseless. Generous safety factors. Dependable. And they cost no more than inferior units!

DATA New 1935 catalog covers complete line of Aerovox resistors and condensers. Copy on request. Also sample copy of **RESEARCH WORKER**.

AEROVOX

CORPORATION

75 Washington St. Brooklyn, N. Y.

A TRIAL WILL CONVINCe YOU

→ 30 Years' Experience ←
Insures Dependability ←

We Manufacture
PERMANENT MAGNETS TOOLS and DIES
METAL STAMPINGS LAMINATIONS

THOMAS & SKINNER STEEL PRODUCTS CO.

23d St. at Alvord

Indianapolis, Ind.

The 300A stands out!

It delivers unusually large audio power at comparatively low plate voltages

THE Western Electric 300 A — a triode developed primarily for Class A operation — delivers unusually large power outputs at comparatively low plate voltages. This tube has contributed to the design of Western Electric high quality amplifiers at relatively low cost.

Two 300 A tubes in push-pull, operating with 450 volts on the plate, will deliver 25 watts, with a total harmonic output of less than 2.0%.

Characteristics that make the 300 A outstanding for high quality audio power are: (1) low plate resistance (2) high mutual conductance (3) low second and third harmonic outputs (4) large plate and bulb, providing ample area for heat dissipation at maximum operating conditions (5) oxide coated filament, rigidly supported, with sufficient area for ample emission.

Like all Western Electric tubes, the 300 A is engineered for highest quality performance and long life. For details, write to Graybar Electric Co., Graybar Building, New York — or telephone Graybar's nearest branch.

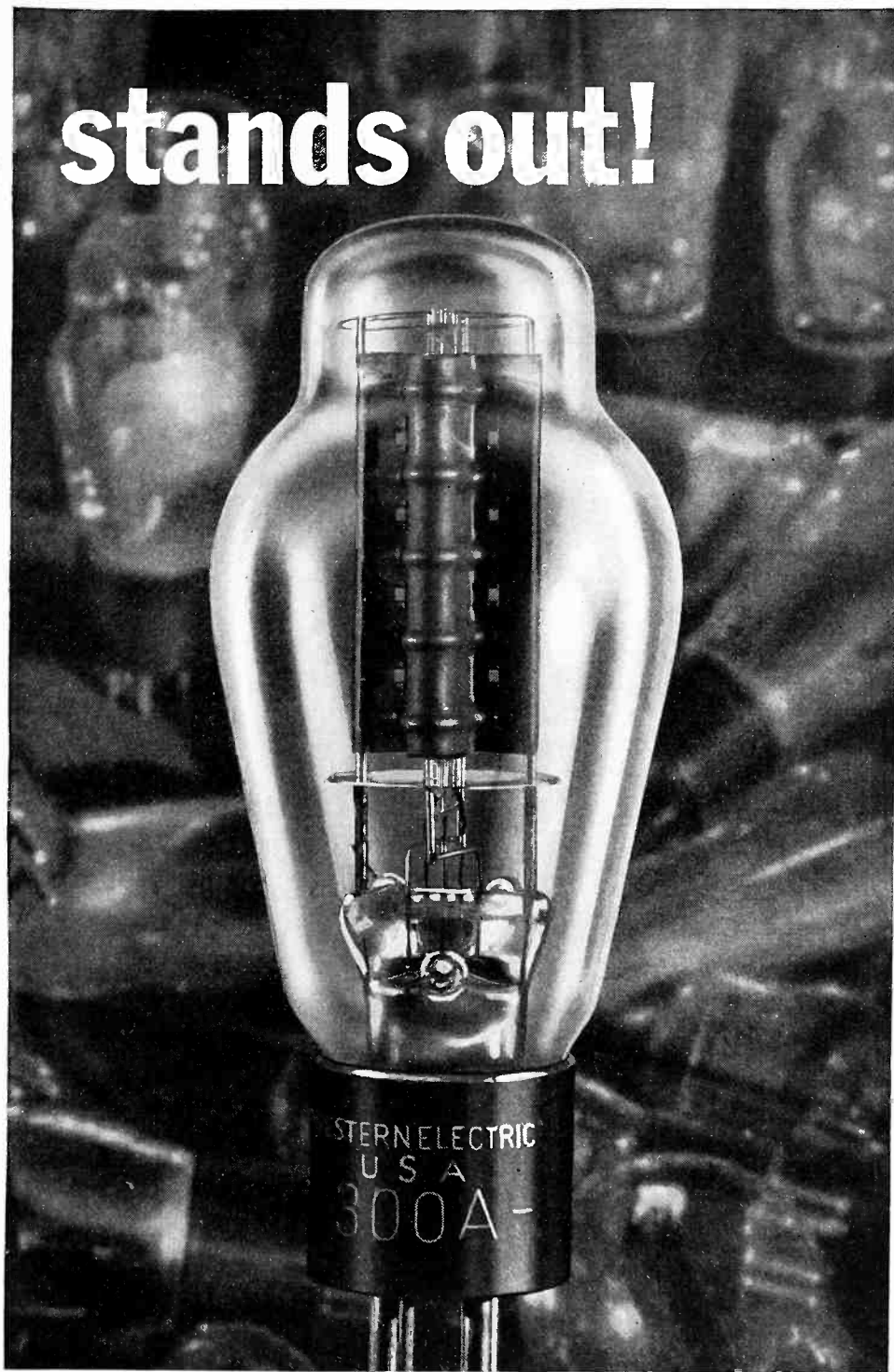

Characteristics of the Western Electric 300A

Filament Voltage...5.0 Volts A.C. or D.C.
 Average Filament Current...1.2 Amperes
 For a Plate Voltage of 350 Volts and a
 Plate Current of 60 Milliamperes:—
 Average Grid Bias.....-74 Volts

Average Amplification Factor.....3.85
 Average Plate Resistance.....740 Ohms
 Average Mutual
 Conductance.....5200 Micromhos

Output Powers:

Plate Voltage.....	250	350	450 (max.) Volts
Plate Current.....	60	60	60 Milliamperes
Load Resistance.....	2000	3000	4000 Ohms
Power Output.....	4.7	8.5	12.5 Watts
Second Harmonic*	5	5	5%
Third Harmonic*	1.2	1.2	1.4%

*Per cent fundamental output current.

Western Electric

RADIO TELEPHONE BROADCASTING EQUIPMENT

Distributed by GRAYBAR Electric Co. In Canada: Northern Electric Co., Ltd.

*Stackpole Presents
a new Midget Control
for Auto Radios*

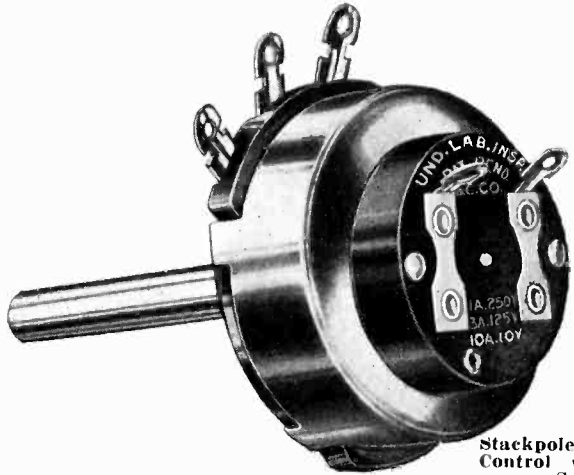

Stackpole Type "C"
Control with Midget
Switch

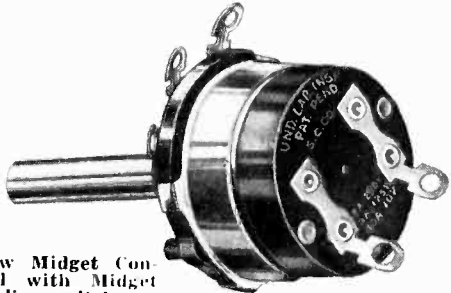

New Midget Control with Midget
line switch.

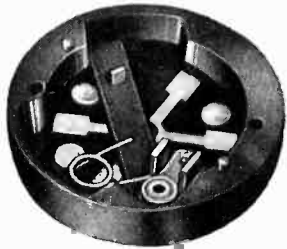

Interior Midget Switch
(open)

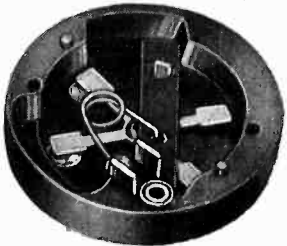

Interior Midget Switch
(closed)

On behalf of modern design and engineering, you've repeatedly asked for a miniature control, with a dependable line switch, replete in all known advantages of larger size controls. You asked for it—our engineers went to work—and now after months of experimental work, we have it! A MIDGET CONTROL by STACKPOLE—100% accurate—not a single outstanding point of our larger controls is sacrificed.

The NEW MIDGET CONTROL is a "natural" for the makers of the new Auto Radios where, at best, space is at a minimum. It's a "find" for the makers of modern household receivers—the line switch carries the APPROVAL of the UNDERWRITERS LABORATORIES.

Each terminal of the switch has two contacts—insuring POSITIVE CONTROL and LOWEST possible CONTACT DROP. MIDGET CONTROLS are available in Types "MB" and "MP." In applications where space is at a premium and our type "C" control is essential—the MIDGET SWITCH is recommended in place of our S-1 Type switch.

Write for detailed data on complete STACKPOLE line.

Stackpole Carbon Company
St. Marys, Pa. U. S. A.

**ELECTRICAL
INSULATION**

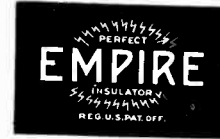

... Varnished Cloth, Tapes,
Silks and Papers



... Plates, Segments, Rings,
Tapes, Tubes, Washers



... Laminated Bakelite
Fabricated Parts, Sheets,
Rods and Tubes



... Untreated Papers, Linen
and Silk Tapes, Varnishes,
Fibre, Spaghetti Tubing,
Cotton Sleeving, etc.

RAW MICA, Uncut blocks, or cut to size.
MICA SHAPES

200 Varick Street, New York; 542 So. Dearborn Street, Chicago;
1276 W. 3rd St., Cleveland. Branches at: Birmingham, Boston,
Cincinnati, Los Angeles, San Francisco, Seattle, Montreal, Toronto.

MICA INSULATOR CO.

ASTATIC

S-TYPE CRYSTAL PICKUPS

HIGH FIDELITY!
ECONOMICAL!
PROFESSIONAL!
GUARANTEED!



LICENSED UNDER BRUSH DEVELOPMENT CO. PATENTS
See your jobber or write for literature.

ASTATIC MICROPHONE LAB., INC., YOUNGSTOWN, OHIO
"Pioneer Manufacturers of Quality Crystal Products"

TRANSFORMERS

Engineers and
manufacturers of
transformers for Radio,
Television, Neon, and
other voltage regulation or
adjustment applications.



**The ACME ELECTRIC
& MANUFACTURING CO.**
1447 Hamilton Ave., Cleveland, O.

Leaders in their field!

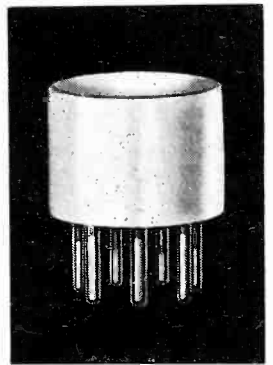
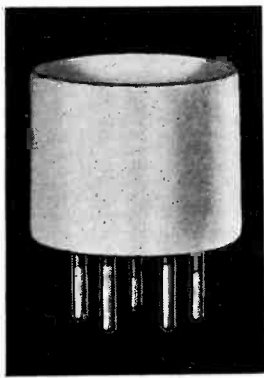

THE development from the original Fleming valve to these modern vacuum tube devices is a long story. It is a story of unceasing effort to improve manufacturing methods and to find new and better materials.

For years the leading tube manufacturers have been using ISOLANTITE insulation—a tribute to the quality and dependability of a product which has contributed much to the production of better vacuum tubes.

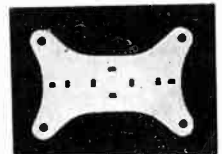
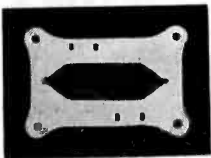

Your tubes also can be improved by the use of ISOLANTITE insulation. *Isolantite Inc., Factory at Belleville, N. J. Sales Office at 233 Broadway, New York, N. Y.*

Isolantite

CERAMIC INSULATORS

SHAKEPROOF

ENGINEERING

PRODUCTION

LOCKING METHODS

PERFORMANCE

don't

WEAKEN YOUR CHAIN... SALES

FAULTY lock washers, the kind that loosen under vibration, can seriously affect the success of any product. Don't handicap yourself by overlooking this vital factor—play safe by using Shakeproof to hold every connection absolutely tight. The twisted teeth of this positive-action lock washer bite into both the nut and work surfaces and, as vibration increases, they dig in deeper—never permitting the nut to loosen or back off. Go over your product immediately, study each connection carefully and, at least, provide Shakeproof protection for those parts that are most likely to be exposed to vibration. Free testing samples are gladly furnished—write for yours today!



NEW CATALOG

Just off the press—our new 1935 catalog tells you how to solve your locking problems. Also illustrates and explains other patented Shakeproof products—a truly valuable book—send for your free copy today!

SHAKEPROOF

Lock Washer Company

Distributors of Shakeproof Products
Manufactured by Illinois Tool Works

2539 N. Keeler Ave.

Chicago, Ill.



Type 12.
Internal



Type 11.
External



Type 15.
Countersunk



Type 20. Locking
Terminals

U. S. Pat. 1,419,564—1,604,122—1,697,954—1,782,387—Other Pat. Pending—Foreign Pat.

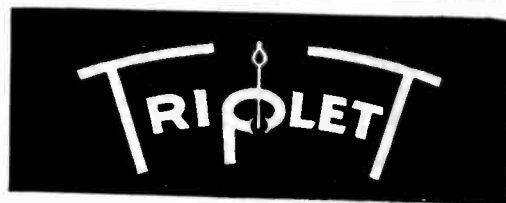

ELECTRICAL MEASURING INSTRUMENTS

for

Industrial and Laboratory Requirements

The Triplet line includes:

VOLTMETERS
MILLIVOLTMETERS
AMMETERS
MILLIAMMETERS
MICROAMMETERS
POWER LEVEL INDICATORS
THERMO-COUPLE AMMETERS
OUTPUT METERS
AC-DC METERS
RELAYS

COMPLETE LINE OF TESTING EQUIPMENT

Furnished in All Popular or Special Models and Ranges

Write for Catalog

THE TRIPLET ELECTRICAL INSTRUMENT COMPANY
172 Main Street
Bluffton, Ohio, U. S. A.

PROCTOR Piezo Reproducer

Modern Records Require a Modern Pickup

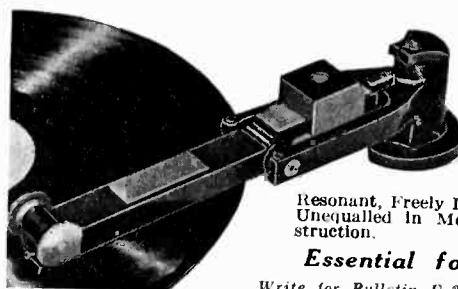

Broadcasting stations and others are definitely turning to the Proctor Piezo Reproducer as an important item in modernizing their equipment. It offers Uniform Response, Extended Frequency Range, High and Low, Minimum Record Wear, Calibrated Needle Pressure Scale, is Non-Resonant, Freely Damped, Non-Magnetic, and Unequaled in Mechanical Design and Construction.

Essential for high fidelity

Write for Bulletin E-2

B. A. Proctor Co., Inc., 17 West 60th St., New York, N. Y.
Designers and Manufacturers of Sound and Recording Equipment.
CABLE ADDRESS: BAPROCTOR NEW YORK



A-P ATTENUATORS

VARIABLE-T-SECTION

Precision non-inductive wire-wound bobbins—thoroughly impregnated, accurate to better than $\frac{1}{2}$ of 1%. 10 steps of $\frac{1}{2}$ -1-2-3 or 5 db each. Standard impedance 200 or 500 ohms, other values of loss or impedance. To order on short notice.

Also furnished in—L-H & Bal. H—mounted in machined cast aluminum shield case $4\frac{1}{2}$ " dia. x $2\frac{1}{4}$ " deep for back of panel mounting. Engraved dial plate and bakelite knob. Order direct. Send check or P.O. order.

VARIABLE-T-ATTENUATOR

Price only \$25 net

Nothing but Quality Products
Since 1910

AUDIO PRODUCTS CO.

4189 W. Second St. A. J. EDGCOMB Los Angeles, Cal.

"We are More than Pleased"

★
"WE SAVED over 50 per cent of assembly time and labor.

★
"WE STOPPED stripping of threads in the Tenite case.

★
"WE ELIMINATED tapping; difficult in cramped space.

★
"WE GAINED 30-40 per cent in production speed.

★
"WE DOUBLED strength of our fastenings; an improvement.

★
"WE AVOIDED countersinking of three battery contacts.

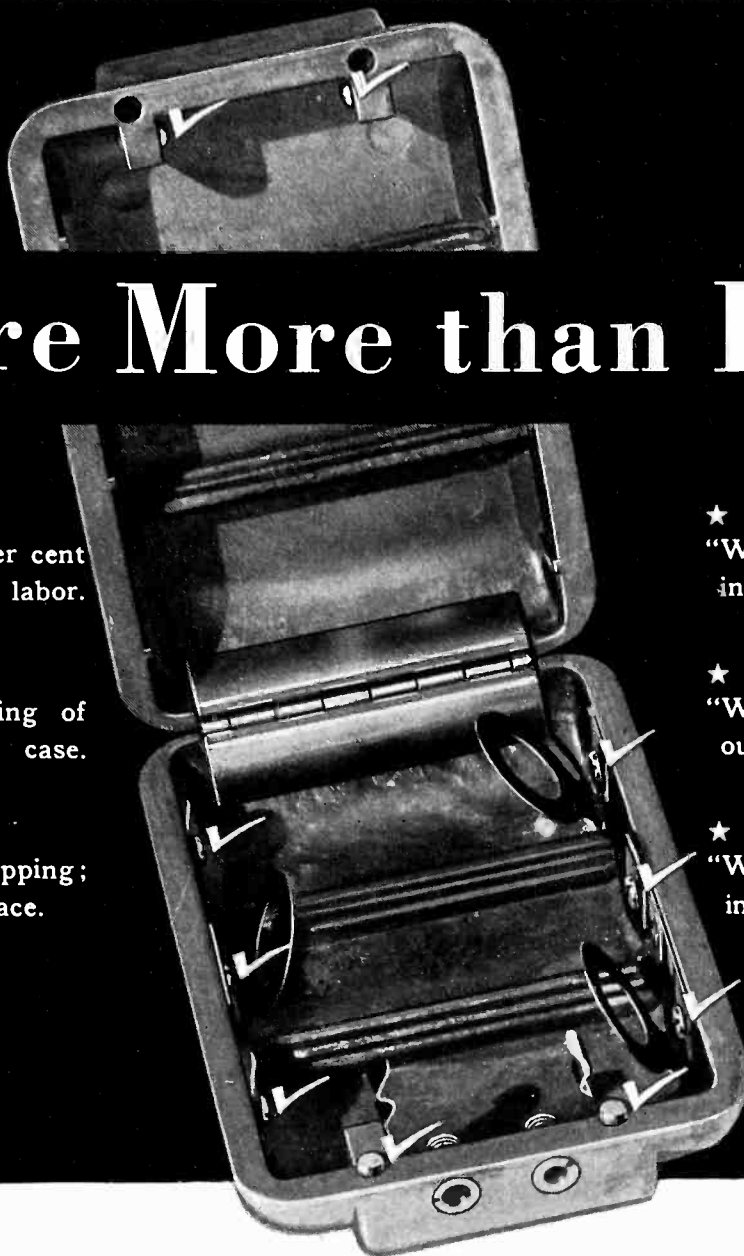

WHAT would Self-tapping Screws do for YOU?

E. A. Myers and Sons, Pittsburgh, read an ad similar to this and decided to try Parker-Kalon Self-tapping Screws for fastening contacts and clips to the molded battery case of their hearing instrument. The trial cost nothing. It required only a few minutes time. Yet, see how it paid.

Hundreds of manufacturers have profited by spending a few minutes in finding out whether

their assemblies could be made cheaper, faster, better with Self-tapping Screws. Seven out of ten times these Screws make a trial worthwhile. Until you try this simplest fastening method you have an unexplored possibility of saving money, speeding-up work, improving your product.

Look over your assemblies now. Check every fastening, whether to metal or plastic material. Send

us a brief description of any fastenings that require tapping, metal inserts, unhandy riveting or other troublesome work. Free samples with the recommendations of our Assembly Engineers will be supplied for test. See for yourself how these Screws save time, labor . . . how they hold more securely than machine screws, etc.

PARKER-KALON CORP.
198 Varick Street New York

PARKER-KALON *Hardened* Self-tapping Screws



Type "Z" Hardened Self-tapping Sheet Metal Screws
For joining and making fastenings to sheet metal up to six gauge; aluminum, die castings, Bakelite, etc. Simply turn Screw into drilled, pierced, molded hole. It forms a thread in the material as it is turned in. Can be removed and replaced.

Type "U" Hardened Metallic Drive Screws

This type of Self-tapping Screw is used for making permanent fastenings to iron, brass and aluminum castings, steel, Bakelite, Durez, etc. Hammer Screw into a drilled or molded hole. It forms a thread in material as it is driven.



Parker-Kalon Products are sold only through recognized distributors

A N N O U N C E M E N T

ELECTRONIC MUSIC is forging rapidly to the fore; it is destined to take an important place in the world of music; the renaissance of the industry has already begun.

With a background of twenty-five years experience in research, invention, and engineering in Radio and Acoustics, we have devoted the past five years exclusively and intensively to the development of Electronic Music Instruments. We have accumulated a large mass of information and experience in this new art relating to its history, its theory, its patent phases, and, particularly, its practice, both here and abroad.

We have evolved many basic principles and designs, covered in thirty already is-

sued patents, and in numerous patent applications. Among these are the Electronic Piano, several types of organ, and other instruments.

Through public concerts, demonstrations, and broadcasts, we have made most satisfactory tests of public reactions.

Knowing that our forte lies in development rather than in manufacturing, we have steadily held to the principle that we would restrict our activities in this field to licensing and consulting, leaving production to others better qualified.

Believing that the time is now ripe for commercialization, we invite inquiries from those interested in producing Electronic Music Instruments.

MIESSNER INVENTIONS, INC • MILLBURN, N. J.

MUTER RESISTANCE BRIDGE
Certified
RESISTANCE BRIDGE

An accurate Bridge of ruggedness, flexibility and wide range. Its remarkably low cost allows a laboratory to own several of them without overloading the budget. Accurate, yet practical for use on production lines. Write Dept. J-7 for new complete catalog of Muter products.

\$29.70
DEALERS NET

The MUTER Co.
1255 South Michigan Avenue, Chicago, Illinois

FIBRE
PHENOL FIBRE
BAKELITE
MICA
FISH PAPER

DON'T GUESS! ASK - CONTINENTAL-DIAMOND

No matter what your insulation problem we may be able to help you. Since we manufacture all forms of laminated insulation—VULCANIZED FIBRE—PHENOL FIBRE—FISH PAPER—CELLULAK—VULCOID—CODITE—our recommendations will be without prejudice. Write us today.

CONTINENTAL-DIAMOND FIBRE COMPANY
NEWARK, DELAWARE

RADIO RECEPTOR Dynamic (Moving Coil) MICROPHONES

Now approach the sensitivity of good carbon microphones.

MODEL 6B Similar in external appearance to 6B. Practically flat from 40-5000. Sensitivity at 3 ft.—49 DB. Sensitivity with transformer TMB—44 DB.

MODEL 6C Practically flat in the voice range. Sensitivity at 3 ft.—59 DB. Designed for Low Priced Systems.
List Price—\$33.00.

We will be glad to mail you more complete information on request on your letterhead.

RADIO RECEPTOR CO., INC.
106—7th Ave., New York City Est. 1922

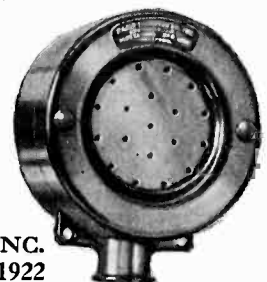

A Plug That Is Shielded—Grounded and Makes a Positive Contact

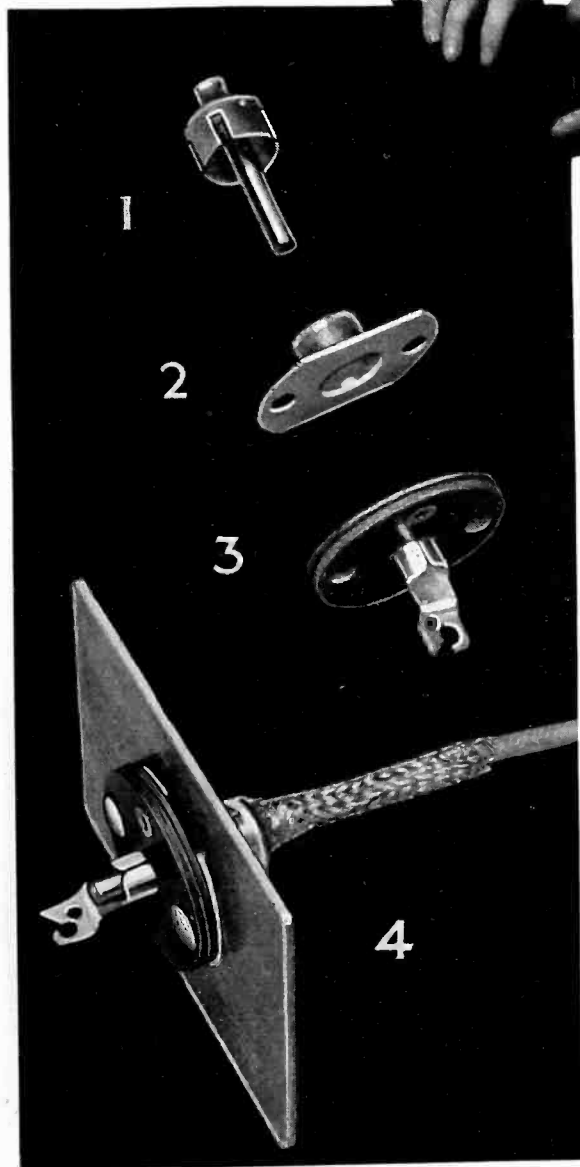
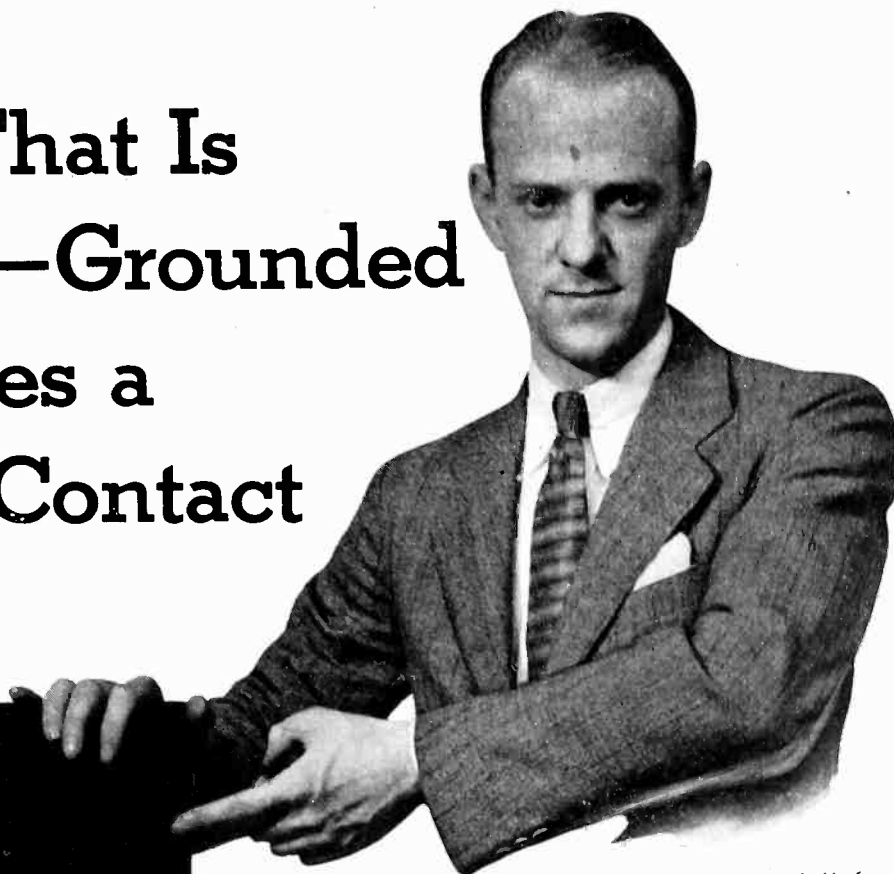

Again Cinch "comes through" for automotive set manufacturers with a shielded connector plug. Eliminates pick-up interference on antennae; pilot light, tone control, "A" leads and speaker cables to chassis! Easy to attach the component parts to chassis and cables! And with a considerable saving in assembly labor! Consider these advantages (a) vibration proof electrical contact; (b) complete metal shielding of lead-in wire through solder joints and wiping contacts direct to chassis (c) with complete grounding.

1. Plug provides a drawn soldering shoulder to which the external cable shielding is attached with solder and also provides split tapering sides which form gripping, grounding contacts to the metal connector base on the chassis. The four gripping fingers on the male shell supply the additional "factor of safety" tension over and above the holding tension of the plug prong in the socket contact which makes the connector plug doubly sure of maintaining its electrical grounding and shielding contacts.

2. The male prong, either .125" or .156" standard tube prong, mounted on an insulator around which the split brass shell is crimped is attached to the external lead-in wire.

3. The connector base is a substitute for an external extrusion in the chassis metal itself and is riveted to and becomes part of the chassis with the same riveting operation that attaches the socket. This connector base, the extruded part of which extends out through the $\frac{3}{8}$ " hole in the chassis is of drawn brass and the opening through which the plug prong passes to the socket is insulated with a fibre bushing curled into place. It is impossible to short out this plug when prong starts its contact in the socket. Bakelite socket receptacles are made for both size prongs .125" and .156".

4. The connector base drawn part is pushed out through the $\frac{3}{8}$ " hole in the chassis and the socket is placed on the back of the base, the mounting holes coinciding in chassis, base and socket. The riveting operation completes the assembly. (Final illustration shows complete assembly.)

The new "Cinch" shielded connector plug is now ready for delivery—write for prices and samples.

Our complete new catalog is now ready. It describes "CINCH" products, practical, efficient, "money-savers." Many of the items illustrated may be helpful to you. Send for your copy—Today!

CINCH

MANUFACTURING CORPORATION

2335 WEST VAN BUREN STREET

CHICAGO, ILLINOIS

Subsidiary: United-Carr Fastener Corporation, Cambridge, Mass.

PIONEER GEN-E-MOTORS for 1935 BATTERY SETS

PIONEER makes a dynamotor for every purpose: a very small compact unit with exceedingly low power drain to replace "B" Batteries. Models to deliver outputs up to 35 watts, 50 watts and a job delivering 225 watts at 1,000 volts.

Other models are special aircraft units; a gas engine driven model delivering 110 volts AC; the AIR-FLO Charger, a

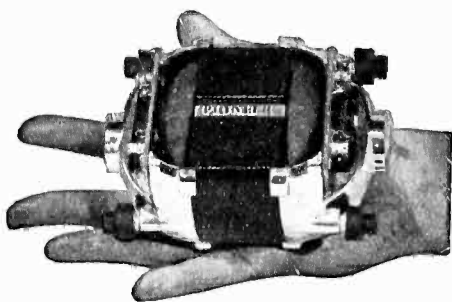

wind-driven generator to charge storage batteries for radio or lighting. PIONEER is the source for every type of dynamotor. Gen-E-Motors keep battery sets sold. Get in touch with the PIONEER engineers about it.

PIONEER GEN-E-MOTOR CORP.

458-A W. Superior St., CHICAGO, ILL.

Cable Address: SIMONTRICE, New York

The A.B.P. Standards of Practice

Men and organizations we like to deal with both have high standards which they follow. So, too, with magazines.

"Electronics"

is a member of the Associated Business Papers, an association of the leading magazines in each field of American business. As a member this magazine has bound itself to abide by these high standards—the A. B. P. Standards of Practice:

1. To consider first the interest of the subscriber.
2. To subscribe to and work for truth and honesty in all departments.
3. To eliminate, in so far as possible, the editor's personal opinions from his news columns but to be a leader of thought in his editorial columns and to make his criticisms constructive.
4. To refuse to publish "puffs," free reading notices or paid "write-ups"; to keep reading columns independent of advertising consideration, and to measure all news by this standard: "Is it real news?"
5. To decline any advertisement that has a tendency to mislead or that does not conform to business integrity.
6. To solicit subscriptions and advertising solely upon the merits of the publication.
7. To supply advertisers with full information regarding character and extent of circulation, including detailed circulation statements, subject to proper and authentic verification.
8. To cooperate with all organizations and individuals engaged in creative advertising work.
9. To avoid unfair competition.
10. To determine what is the highest and largest function of the field which is served, and then to strive in every legitimate way to promote that function.

"Electronics"

A McGraw-Hill publication

is also a member of the Audit Bureau of Circulations, which embraces every leading consumer magazine and newspaper.

Dependability

DURING the last two years **CANNON** Plugs have been installed in more than 200 planes used in daily transport service - - and in these two years not one Plug failure has been recorded **CANNON** Plugs **ARE Dependable.**

New Airship Plug Catalog Available

CANNON PLUGS

CANNON ELECTRIC DEVELOPMENT CO.
MANUFACTURING ENGINEERS

Main Office: 420 West Avenue 33, Los Angeles, California.

Eastern Sales Office: Lewis & Sachs Company,
220 Fifth Avenue, New York.

REPRESENTATIVES:

CHICAGO: Jenkins & Adair, Inc., 3333 Belmont Ave.
DALLAS: Edward F. Aymond, 3750 Urban Ave.
BOMBAY, INDIA: Eastern Electric & Engineering Company, 175 Hornsby Road, Fort, Bombay, India.



PROFESSIONAL SERVICES

ELECTRICAL TESTING LABORATORIES

Characteristics and
Life Tests of Vacuum Tubes
Tests of photo cells, glow lamps, crater lamps.
Tests of electronic and optical devices.
80th Street and East End Avenue
New York, N. Y.
Phone: Butterfield 8-2600

HUDSON BROS. MFG. CO., Inc.

539-41 42nd St., Union City, N. J.
Designers and consultants for experimental glass apparatus, pyrex and soft glass.
Aspirator Pumps Ground Joints
Graded Seals Stop-Cock Grease
Stop-Cocks Pyrex and McLeod Gauges
Soft Glass Traps of all types.
Glass Apparatus Made to Blue Print Specifications.
Tel. Palisade 6-2940

PAUL G. WEILLER

Engineer

Consulting service, design and construction of special electronic timing devices, furnace controls, etc.

405 Lexington Ave., New York
Telephone, Van. 3-6226

THE SOLUTION OF YOUR PROBLEM

might be found through enlisting the services of the firms whose cards appear on this page.

Micamold

TYPE 800 Molded Wirewound RESISTORS

Micamold Type 800 Wirewound Resistors are a decided step forward in the resistor field. They are better because of:

- uniform resistance characteristics of wire.
- small bulk compared with designs of molded carbon type or flimsy flexible units.
- uniformly impervious to moisture.
- lead wires cannot be pulled out; all leads hot tinned for easy soldering.
- make available for first time a resistor having all of the excellent eye-value characteristics of molded condensers.

Micamold Type 800 units are available in resistance up to 2500 ohms. Rating: One Watt.

We invite engineers to investigate the merit of Micamold Products. Foreign radio buyers will find it to their advantage to specify Micamold Condensers and Resistors because of their dependability. We are in position to give prompt service to foreign manufacturers.

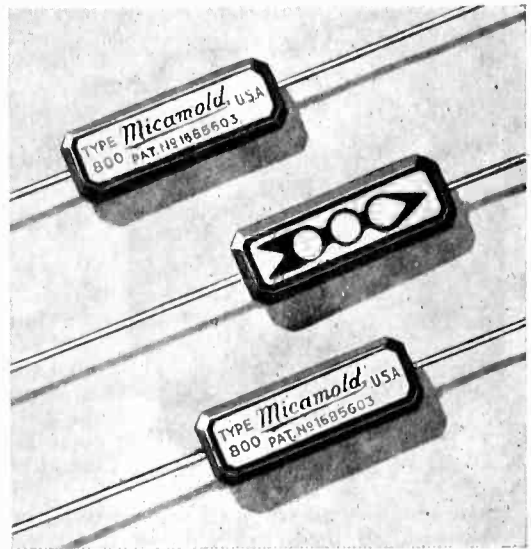

MICAMOLD RADIO CORPORATION

Manufacturers of Condensers and Resistors Exclusively

MEMBER R. M. A.

1087-1095 FLUSHING AVENUE

BROOKLYN, N. Y., U. S. A.

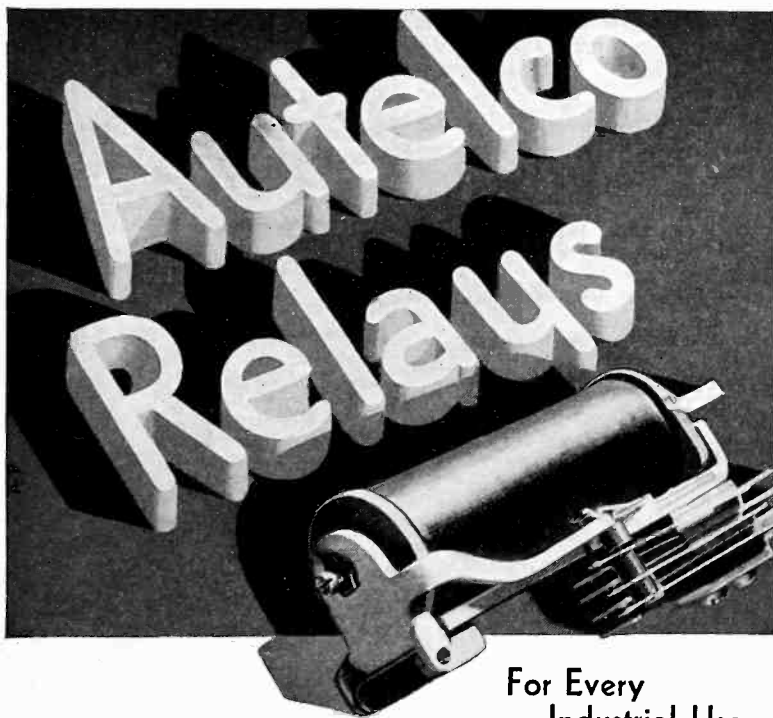

For Every
Industrial Use

WHEN buying relays, the name Autelco is worth insisting upon. It means that back of that relay is over forty years of relay designing and manufacturing experience — insurance of perfected design and trustworthy operation. A complete description of all types and sizes for every purpose will be found in catalog 4016-A — sent free upon request.

AUTOMATIC ELECTRIC COMPANY...Chicago, Illinois

HIGH IMPEDANCE HEADPHONES



These phones present new distinct advantages for monitoring, testing and other applications where wide range response is required.

1. Reproduction Range 60-12,000 cycles.
2. Operating on the piezo-electric principle they have extremely high current sensitivity.
3. May be operated from any normal source regardless of impedance.
4. Non-magnetic and will consequently not affect compasses, watches or other instruments.
5. No overloading possible within usable range of sound levels.
6. Phones are extremely light in weight—six ounces including band and cord.

For further information write

THE BRUSH DEVELOPMENT CO.

East 40th and Perkins Ave.
CLEVELAND, OHIO, U. S. A.

TRANSFORMERS

for Transmitting

AmerTran's line of transmitting equipment includes standard air-cooled transformers and reactors for all power-supply circuits utilizing either type '66 or '72 rectifiers. It is high-quality apparatus of exceptionally flexible design and is moderately priced.

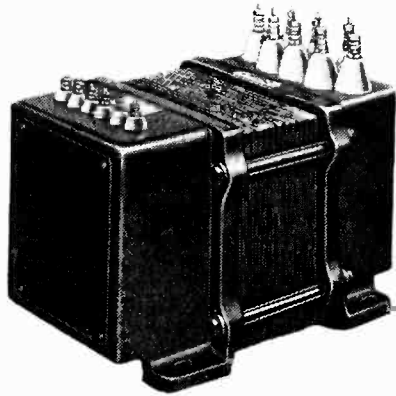

Plate Transformers

Plate transformers have split windings on both the primary and secondary side so that they may be operated with either 115 or 230 volts input and may be used in banks on three-phase circuits as well as singly in

single-phase rectifiers. All units are of the fully enclosed type with all leads brought out through bushings. Two taps are provided for reduced voltage.

Filament Transformers

Filament transformers of the fully enclosed type have 5% regulation from full load to no load and will operate continuously with 30° C. maximum temperature rise. All secondary windings are carefully centertapped with leads brought out through bushings. Primary windings are split (115/230 v.) and have low-voltage taps to permit use of rheostat for closer regulation.

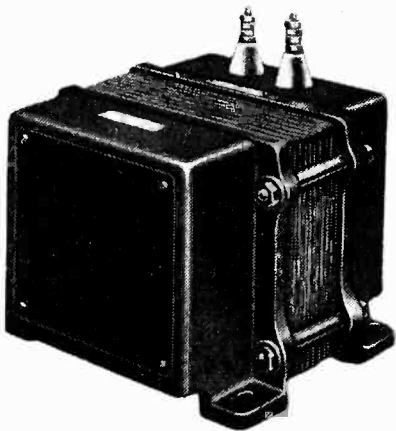
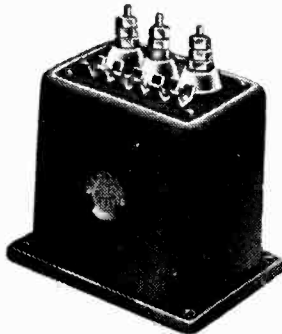

Filter Reactors

Filter reactors of the closed type are similar in appearance to plate transformers. Leads are brought out through high-voltage bushings and many types are available with split windings to permit parallel connection for

handling double current with one-quarter rated inductance. All ratings are available with insulation tested at either 7,500 or 15,000 volts r.m.s.

For complete ratings and prices refer to Bulletin No. 1002—copy sent on request.

AMERICAN TRANSFORMER COMPANY
180 EMMET ST., NEWARK, N. J.



AMERTRAN TRANSFORMERS



CONTENTS for JULY, 1935

Money for plant expansion.....	205
Radio art advances told at IRE convention.....	205
Applications of electronic engine indicators.....	212
BY IVAN BLOCH	
High resistance measurement with vacuum tubes..	214
BY ALBERT PREISMAN	
Electrolytic capacitor testing in production.....	216
BY PAUL MACKNIGHT DEELEY	
Radio on board the Normandie.....	218
Adjusting the class B linear power amplifier.....	219
BY L. B. HALLMAN	
High lights on electronic devices in industry.....	220
Measured input losses of vacuum tubes.....	222
BY C. J. FRANKS	
Notes on electron tubes and circuits.....	224
Editorials.....	226
A review of the electronic art.....	228
New products.....	231
U. S. patents.....	234

INDEX TO ADVERTISERS

This index is published as a convenience to the reader. Every care is taken to make it accurate but *Electronics* assumes no responsibility for errors or omissions.

	Page		Page
Acme Elec. & Mfg. Co.....	12	Radio Receptor Co.....	16
Aerovox Corp.....	10	RCA Mfg. Co., Inc.....	Back Cover
Allen-Bradley Co.....	22	Remler Co., Ltd.....	8
American Transformer Co.....	20	Shakeproof Lock Washer Co.....	14
Astatic Microphone Lab.....	12	Stackpole Carbon Co.....	12
Audio Products Co.....	14	Superior Tube Co.....	2-3
Automatic Electric Co.....	19	Thomas & Skinner Steel Prod. Co.....	10
Bakelite Corp.....	Inside Front Cover	Triplett Elec'l Instr. Co.....	14
Brush Development Co.....	19	Western Electric Co.....	11
Cannon Electric Development Co.....	18	Westinghouse Elec. & Mfg. Co.....	Inside Back Cover
Cinch Mfg. Corp.....	17	White Dental Mfg. Co., S. S.....	1
Continental Diamond Fibre Co.....	15		
Erie Resistor Corp.....	5	Professional Services.....	18
Formica Insulation Co.....	7		
General Electric Co.....	9	SEARCHLIGHT SECTION	
General Radio Co.....	10	Classified Advertising	
Goat Radio Tube Parts, Inc.....	8	Employment.....	21
Guthman & Co., Inc., Edw. I.....	8	EQUIPMENT FOR SALE	
Isolantite, Inc.....	13	American Electrical Sales Co.....	21
King Laboratories, Inc.....	10	Eisler Engineering Co.....	21
Mallory & Co., Inc., P. R.....	4	Grigsby-Grunow Co., Inc.....	21
Mica Insulator Co.....	12	Kahle Engineering Co.....	21
Micamold Radio Corp.....	19	Madison Square Garden Corp.....	21
Miessner Inventions, Inc.....	16	National Radio Tube Co.....	21
Muter Co., The.....	16		
Parker Kalon Corp.....	15		
Pioneer Gen-E Motor Co.....	18		
Precision Resistor Co.....	8		
Proctor Co., Inc., B. A.....	14		

McGRAW-HILL PUBLISHING COMPANY, INC.,
330 WEST 42d STREET, NEW YORK, N. Y.

Branch Offices: 520 North Michigan Ave., Chicago; 883 Mission St., San Francisco; Aldwych House, Aldwych, London, W. C. 2; Washington; Philadelphia; Cleveland; Detroit; St. Louis; Boston; Greenville, S. C. James H. McGraw, Chairman of the Board; Malcolm Muir, President; James H. McGraw, Jr., Executive Vice-President; Howard Ehrlich, Vice-President; B. R. Putnam, Treasurer; D. C. McGraw, Secretary.

SEARCHLIGHT SECTION

RADIO TUBE, LAMP AND NEON SIGN MANUFACTURERS

SAVE MONEY

We have a very fine stock of used Radio Tube Manufacturing equipment which can be purchased at a fraction of its actual value.

Exhaust Machine Units — Eisler 24 Head, complete with Vacuum Pumps, Bombarders, Sealing Machine Control Panels, etc., capable of 300 Tubes per hour.

Bombarders—Lepel Type 4 and 5 K.W., complete.

Vacuum Pumps—Megavac, Kinney, Eisler, Berrenberg.

Baseing Machines

Hot Cut Flare Machines

Stem Machines

Tubulating Machines

Branding Machines

Filament Coating Units

Furnaces, Vacuum and Hydrogen

Generator Sets, Electric Tube Testing and Seasoning Equipment

Detailed Descriptions and Prices Furnished Upon Request

GRIGSBY-GRUNOW COMPANY, INC.

in liquidation by order of the United States District Court

FRANK M. McKEY, Trustee

5801 Dickens Ave.

Phone, Berkshire 7500

CHICAGO, ILL., U.S.A.

Cable Address—Grigaut

POSITIONS WANTED

ELECTRICAL ENGINEER, wide experience electronics, especially remote control, telemetering, alarm systems, robot aircraft equipment, altimeters, flaw detectors, special amplifiers, desires position. Now employed. PW-70, Electronics, 520 No. Michigan Ave., Chicago, Ill.

RADIO TOWERS FOR SALE

Two—80-ft. radio towers made up in 10-ft. sections—now atop Madison Square Garden, New York. Offered for quick sale to highest bidder. Address

Col. J. R. KILPATRICK, Pres.
Madison Square Garden Corporation
307 W. 49th St., New York City

"SEARCHLIGHT" RATES

Electronics

UNDISPLAYED:

Positions Wanted—5 cents a word, minimum charge—\$1.00 an insertion.

Positions Vacant and other classifications—10 cents a word, minimum charge \$2.00 an insertion. Allow 10 words for box address. No additional charge for forwarding replies.

Discount of 10% for payment in advance on 4 consecutive insertions of undisplayed advertisements.

Proposals—40 cents a line.

DISPLAYED:

Space is sold by the "Inch," with 30 inches to a page (An "Inch" measures approximately 1 inch high by 2 1/4 inches wide.) Rates are from \$5.00 to \$3.00 an inch, depending on the total space used. 0226

All types of High Grade New and Used Equipment for the manufacture of Electron Tubes.

Lowest prices on the market.

AMERICAN ELECTRICAL SALES CO.

65 East 8th St., New York, N. Y.

Cable Address "AMELSACOMP-NEW YORK"

Charles Eisler offers the trade a complete line of new, used and reconditioned

EQUIPMENT for making

Electronic Tubes Radio Tubes
Incandescent Lamps Neon Sign Tubes

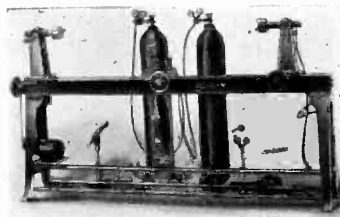

TUBE SEALING LATHE

Air Blowers	Flare	Electric Furnaces
Vacuum Pumps	Stem	Glass Apparatus
Aspirators	Winding	Vacuum Testers
Gas Boosters	Sealing	Gas Economizers
Spot Welders	Exhaust	Crossfiles
Gas Burners	Basing	Ribbon Burners
Accessories	Machines	Gas Purifiers

Write for literature

EISLER ENGINEERING CO.

751 SO. 13TH ST. NEWARK, N. J.

HIGH GRADE NEW AND USED ELECTRON TUBE EQUIPMENT

Write for Bulletin Showing Savings
From 20% to 80%

KAHLE ENGINEERING CORPORATION
Specialists in Equipment and Methods for the
Manufacture of Neon Tubes, Radio Tubes, Incandescent Lamps, Photo Cells, X-ray Tubes, etc.
350 Manhattan Ave., Union City, N. J.

★ SERVICE ★

is our Watchword—we hold ourselves ready to meet your Emergency Needs—Try our Reconditioning Service for that Spare Tube so Vital to the Station.

NATIONAL RADIO TUBE CO.
INC.

3420-18th St. San Francisco, Calif.

It's Noiseless!
It's Compact!



The Type J Bradleyometer

**Unaffected by wear . . .
 Permanently quiet**

Noiseless—a low resistance carbon block makes smooth contact with the polished surface of a molded circular resistor. Wear does not change the contact resistance, hence the control remains permanently noiseless.

Compact—only 1-1/16" in diameter. Ideal for auto-radio tuning heads and midget radios.

Unaffected by high humidity—the resistor, of solid uniform cross section, is not affected by moisture. It never changes. Practically any resistance gradation can be provided. Write for complete specifications, today!

ALLEN - BRADLEY COMPANY
 110 West Greenfield Avenue, Milwaukee, Wisconsin

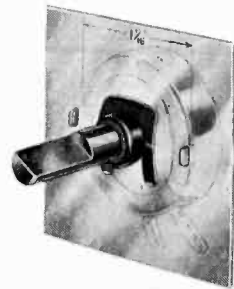

Reduces assembly costs! Snaps into place on panel with C-Washer.

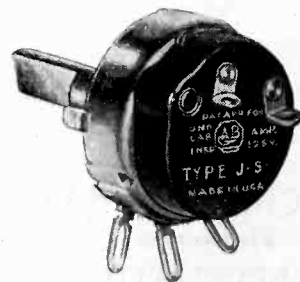

Quick-acting, positive contact shielded line switch is supplied on Type JS Bradleyometers. Back panel depth 9/16". Diameter 1-1/16".

**ALLEN-BRADLEY RADIO RESISTORS
 RADIO CONTROLS**

DESIGNED SPECIFICALLY for Industrial Applications

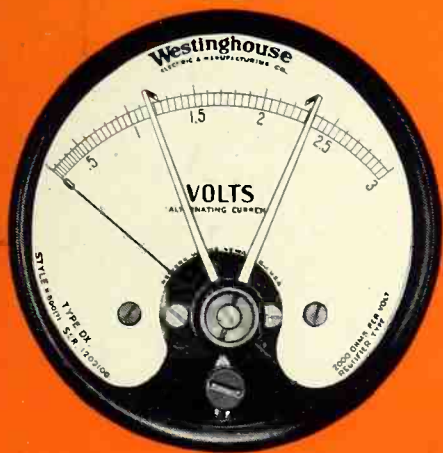

Type D instruments are ideal for speeding up production testing operations. All ratings can be supplied with knife-edge and limit pointers for use as production testing standards. The limit pointers can be manually adjusted from the front of the instrument to show maximum and minimum limits for any part of the scale. These pointers allow easy reading without calculating scale divisions.

In case extremely accurate test data is desired, the knife-edge pointer assures precision reading.



Type DY, a-c. instruments are available as single and polyphase wattmeters, single and polyphase power factor meters, and frequency meters.



Type DY-2 instruments are alternating-current ammeters and voltmeters which may be obtained either self-contained or for use with instrument transformers.

A COMPLETE LINE of Medium-Sized Instruments

When your switchboard space is limited, but where high-quality instruments are required, specify Westinghouse type D. These 4-inch instruments bring to the class of *medium-sized* round instruments the same high qualities of high accuracy, long life, and ease of reading that so distinctly mark the large Westinghouse square-type instruments.

Made in both projection and flush-mounting designs, a-c. or d-c., in all required ratings, these 4-inch instruments combine all of the many instrument advantages which Westinghouse has pioneered, developed, and proved since 1888.

For more detailed information about Westinghouse type D instruments, just ask for a copy of C. S. 43-320.



FLUSH MOUNTING



PROJECTION MOUNTING

Type DX, d-c. instruments are available in single and double-range milliammeters, self-contained and shunt-type ammeters, microammeters, single-range and multi-range voltmeters, millivoltmeters, self-contained and external thermo-couple radio-frequency ammeters, and Rectox voltmeters and milliammeters.

R 57036

Westinghouse

THE GREATEST RADIO TUBE ADVANCE IN 28 YEARS

ALL-METAL RADIO TUBES

Sponsored by Two Great Names—Designed by  Made by 

22 LEADING RADIO MANUFACTURERS HAVE ALREADY ADOPTED RCA METAL TUBES AS STANDARD EQUIPMENT



6H6—The new AVC tube



6C5—Triode Detector-Amplifier



6L7—Pentagrid Mixer-Amplifier



6K7—Triple-Grid Variable-Mu Amplifier



6E6—Pentode Power Amplifier



6A7 in shield compared with its equivalent, the new 6A8. Note great saving in space.

Recent great advances in electrically controlled welding and new metal alloys make this achievement possible

A Few of the Exclusive Advantages and Selling Features:

1. All metal construction.
2. Extreme quietness due to all metal.
3. Compactness, resulting in improved engineering design.
4. Self-shielding.
5. Uniform shielding.
6. Better short-wave performance, due to perfect shielding.
7. New Octal base, with self-aligning plug and key.
8. Electrically-welded and mechanically-locked base.
9. Rugged mount, supported by 7 or more wires leading directly to base pins.
10. Designed by G. E., made to new high precision standards by RCA.

ENGINEERS NOTE: RCA Metal Tubes enhance both the performance and saleability of radio receivers employing them. Hence the wisdom of employing these newest and most sensational radio tubes in the receivers you are designing. Full technical data sent on request.



RCA RADIO TUBES

RCA RADIOTRON DIVISION, RCA MANUFACTURING CO., INC., CAMDEN, NEW JERSEY